

Panasonic



RESIDENTIAL HEAT PUMP SOLUTIONS FULL LINE CATALOG



SINGLE ZONE AND MULTI-ZONE

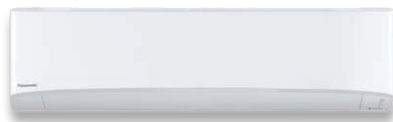

 nanoeX™

 INVERTER

2021 PRODUCT LINEUP

A Better Life, A Better World

Panasonic has produced over 100 million* air conditioning and heat pump units worldwide.

Global Brand

Our global brand serves over 100 countries in all climate zones around the world.

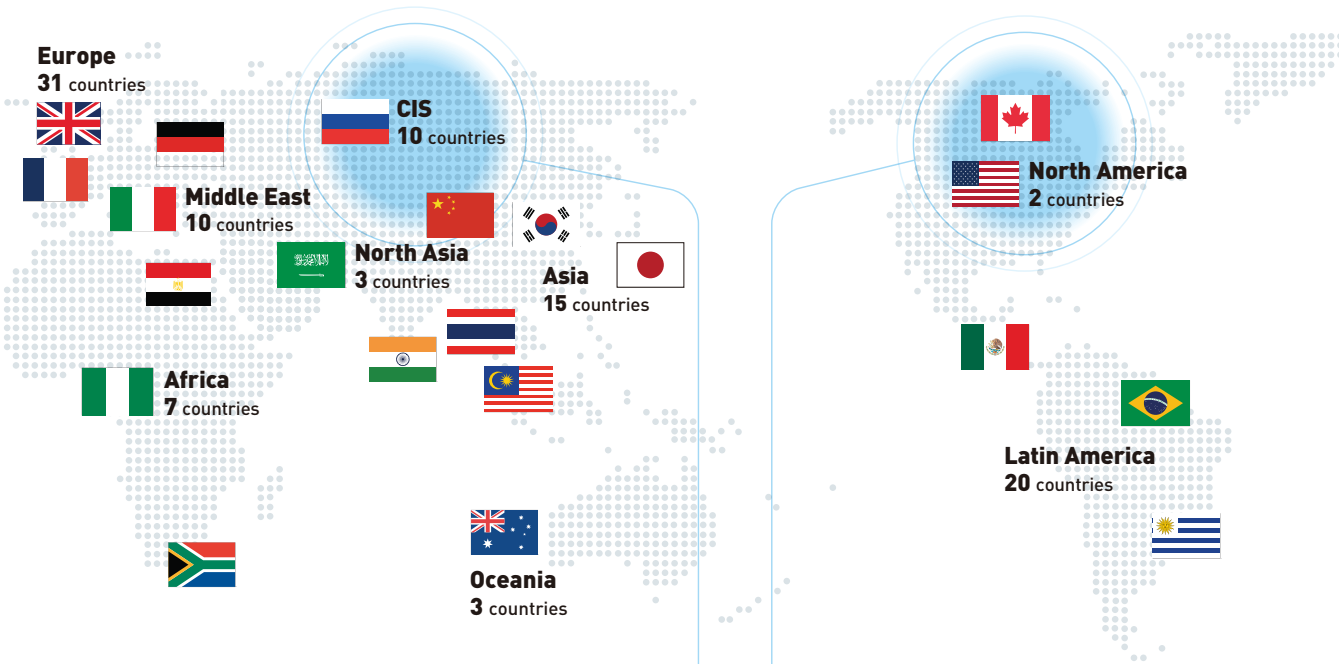

Our air conditioner designs consider local climate characteristics and are used in a wide range of extreme hot to extreme cold regions and countries.



Outdoor units are affected by extreme weather conditions which also affects the units performance.

In extreme cold climate and heavy snow fall conditions it is necessary to protect the outdoor unit from freezing.

Panasonic has developed special knowledge and technology for cold climate regions including Siberia and North America.

Panasonic can be characterized as a global pioneer in extreme cold climate heat pump design and installations.

* As of the end of 2014 (According to our research)

Our Evolution

Forever and ever.

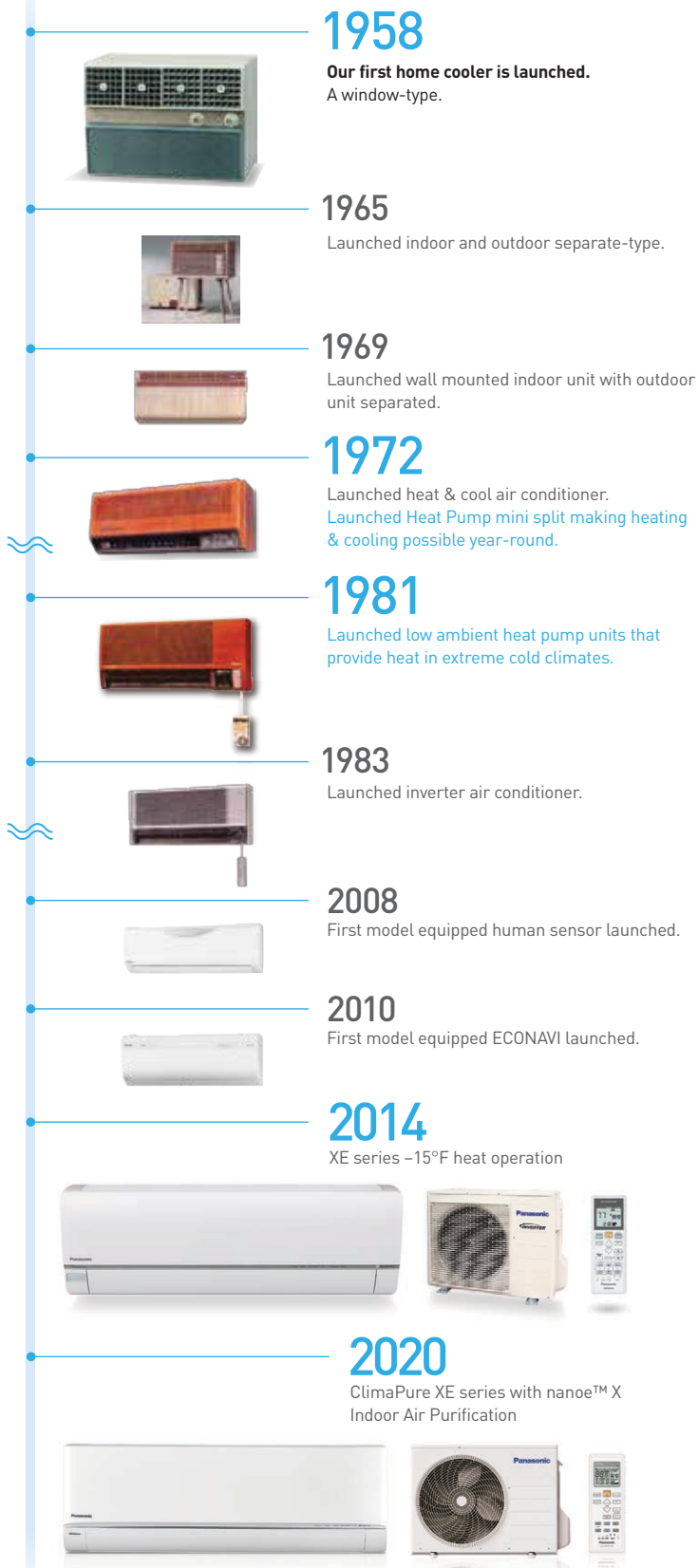

Index

- 2 About Panasonic
- 3 Our Technology Evolution
- 4 New nanoe™ X Technology
- 6 The Effectiveness of nanoe™ X Technology
- 10 New Built-in Wi-Fi & Panasonic Control App
- 12 New Voice Control: Google and Amazon VPA Speakers
- 14 Rugged, Precise Design, and Toughness
- 16 Quality and Reliability
- 18 Heating and Cooling for All Seasons
- 20 Advanced Inverter & ECONAVI Technology
- 22 Air Conditioner and Heat Pump Line-Up
- 24 Model Feature Chart
- 25 Features
- 26 ClimaPure™ XE Series Wall-Mounted Heat Pumps
- 28 Deluxe E Series Wall-Mounted Heat Pumps
- 29 Pro RE Series Wall-Mounted Heat Pumps
- 30 Pro YE Series 115v Wall-Mounted Heat Pumps
- 31 Slim Duct Heat Pumps (RAC)
- 32 4-Way Ceiling Cassette Heat Pumps (RAC)
- 33 Multi-Zone Outdoor Units
- 34 Multi-Zone Indoor Units Combinations and Specifications
- 38 2 Zone System
- 39 2-3 Zone System
- 40 2-4 Zone System
- 41 2-5 Zone System
- 42 Multi-Zone Combination Charts
- 44 Residential Controllers (RAC)
- 45 Built-in Wi-Fi and Panasonic Control App
- 46 Wi-Fi Adapters and App
- 47 Wireless Home - BACNet Integration
- 48 LonWorks Integration, RAC Connectivity
- 49 Controllers, Communications and Integrations
- 50 Accessories / Line Sets
- 51 Pipe Lengths, Fittings, Elevations and Refrigerant
- 52 Operation Range / Multi-Zone Wiring
- 53 Multi-Zone Tube Adapters
- 54 Model Identification

Experience a fresher and more comfortable indoor environment

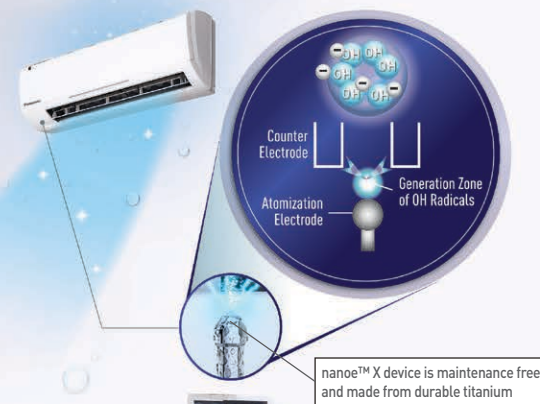

7 effects of nanoe™ X air purification technology

<p>Deodorizes</p> <p>Odors</p>	<p>Inhibits 5 types of pollutants*</p> <p>Bacteria & viruses</p> <p>Mold</p> <p>Allergens</p> <p>Pollen</p> <p>Hazardous substances</p>	<p>Moisturizes</p> <p>Skin & hair</p>
---------------------------------------	--	--

*nanoe™ X reduces the concentration of select pollutants, mold, allergens, pollen, PM2.5, and odors and the growth of certain viruses and bacteria, but does not prevent them.

What is **nanoe™**?
nano-technology + electric =



nanoe™ X is the next generation of nanoe™ technology and is generated from moisture in the air that contains highly reactive components known as hydroxyl (OH) radicals, which are effective at suppressing pollutants and odors.

4.8 trillion OH radicals / sec

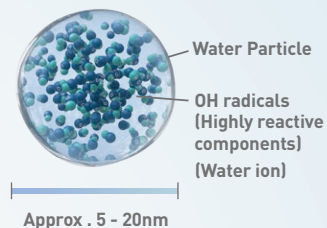

How **nanoe™** works?

Deodorizes Odors



Inhibits Airborne and Adhered Pollutants



Helps maintain skin moisture

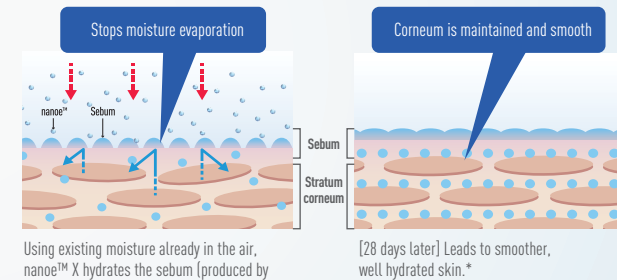

Using existing moisture already in the air, nanoe™ X hydrates the sebum (produced by sebaceous glands to lubricate the skin) on the skin to help prevent loss of moisture.

*Test Laboratory: FCG Research Institute Inc. Report no. 19104

nanoe™ X inhibits both airborne and adhered pollutants and odors in the home

✓ **Helps create an environment that's clean and safe for babies**

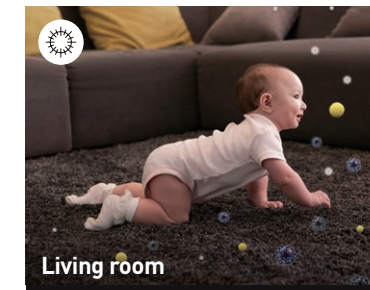

The carpets where babies spend much of their time conceal a great deal of mold, bacteria, viruses and allergens deep in their fibers. nanoe™ X inhibits these pollutants, helping to make carpets cleaner and safer for babies.

✓ **Makes homes more comfortable for families with pets**



Mites and dander from pets are a major cause of allergies in the home. nanoe™ X not only effectively inhibits these allergens but also eliminates many odors that permeate mattresses, blankets and more.

✓ **Keeps the living room fresh and inviting**



The smell of unpleasant odors tends to permeate furniture and curtains over time. nanoe™ X inhibits odors, leaving the air in your living room fresh and inviting.

✓ **Protects your valued clothing and other stored items**

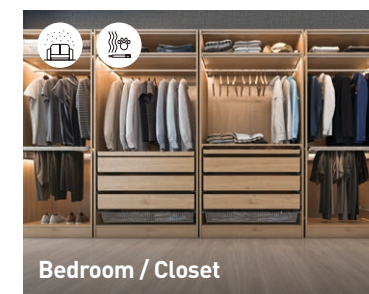

Air tends to become stale and humid inside closets, encouraging the growth of mold. nanoe™ X inhibits the growth of mold to help protect your clothing and other stored items.

✓ **Inhibits harmful substances in PM2.5 brought in from outside**

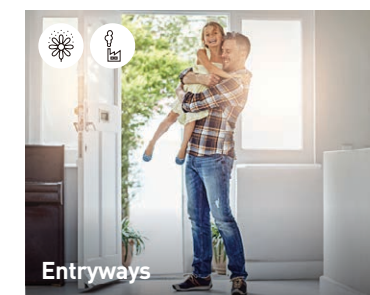

Harmful substances in PM2.5 and pollen that are thought to cause asthma, bronchitis and other health issues tend to cling to your clothing and hair when you come in from outside. nanoe™ X breaks down and inhibits these substances.

✓ **Moisturizes skin and hair for a little extra self-care**



nanoe™ X helps keep your hair and skin moisturized while you sleep or spend time with your family. nanoe™ X hydrates the sebum on the skin to prevent the loss of moisture.



Ozone concentration during the nanoe™ X generating mode has been verified by California Air Resources Board (CARB) and INTERTEK respectively per authorized testing standards.

- Standard value of California Air Resources Board (CARB): 0.05ppm or lower
- Standard value of INTERTEK "Verified Zero Ozone": 0.005ppm or lower



Panasonic's Advanced Air Purification System

Panasonic's nanoe™ Technology is a revolutionary air purification system that helps keep your living space fresh and clean for you and your family.



The effects of nanoe™ Technology are recognized by experts in each field

Recommended for use in facilities such as medical institutions where greater cleanliness is required



Professor Masafumi Mukamoto
Osaka Prefecture University
Veterinary Infectious Disease Studies

Various types of molds enter houses along with people and air. Even if preventive action is taken in our everyday lives, it is often very difficult to inhibit the growth of mold, especially in humid environments. With nanoe™ X, we have experimental results*1 that show we can inhibit the growth of the types of mold commonly found in various places in the house. As nanoe™ X is also capable of inhibiting invisible bacteria and viruses that exist in our living environment, I recommend that equipment incorporating nanoe™ X technology be placed in buildings where cleanliness is required, such as in schools, childcare facilities and medical institutions.**

*1 Experimental results show that nanoe™ X is effective in inhibiting the growth of the following types of mold commonly found in homes: Cladosporium, Aspergillus, Penicillium, Alternaria, Fusarium, Eurotium, Mucor, and Stachybotrys.
** The above indications and statements are made in reference to available information.

Hope for the creation of more comfortable spaces for those who have problems with asthma or atopic dermatitis



Professor Masahiro Sakaguchi
Azabu University School of Veterinary Medicine
Department of Veterinary Medicine

We have experimental results that show nanoe™ X is capable of inhibiting allergens, such as pollen and dust mites. It is important to take precautions against the allergens that we inadvertently inhale in our daily lives.

As nanoe™ X is effective in inhibiting invisible allergens, we can expect it will create a cleaner environment.**

The Effectiveness of nanoe™ X Technology

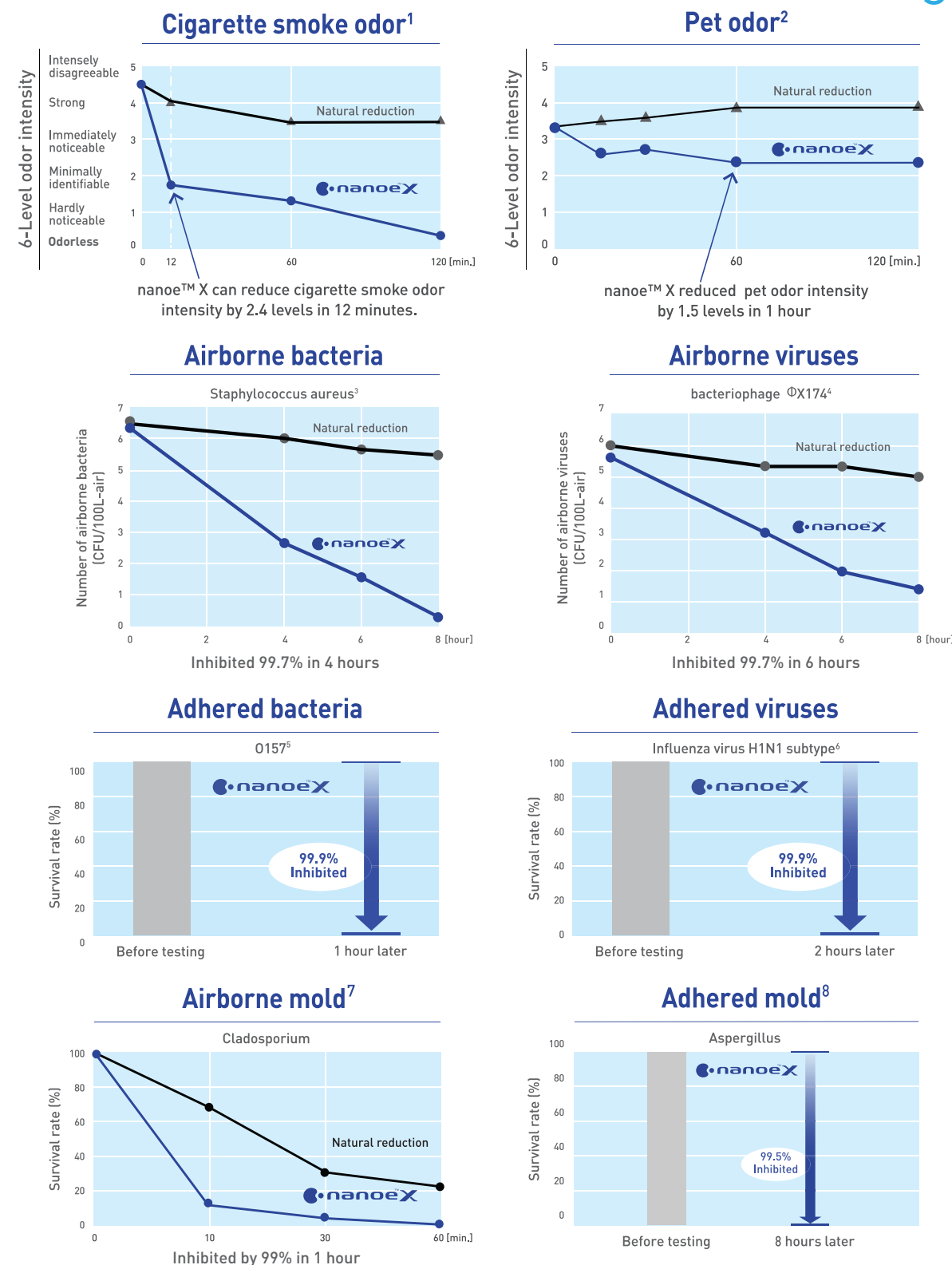

* nanoe™ X reduces the concentration of select pollutants, mold, allergens, pollen, PM2.5, and odors and the growth of certain viruses and bacteria, but does not prevent them.

¹ <Cigarette smoke odor> [Test org.] Panasonic Product Analysis Center [Test method] Verified using the six-level odor intensity scale method in an approximately 23m² sized test room (Deodorization method) nanoe™ released [Test substance] Surface-attached cigarette smoke odor [Test result] Odor intensity reduced by 2.4 levels in 12mins (4A433-16015-N04)
² <Pet odor> [Test org.] Panasonic Product Analysis Center [Test method] Verified using the six-level odor intensity scale method in an approximately 23m² sized test room (Deodorization method) nanoe™ released [Test substance] Surface-attached pet odor [Test result] Odor intensity reduced by 1.5 levels in 1 hour (4A433-160315-A34)
³ <Airborne bacteria (Staphylococcus aureus)> [Test org.] Kitasato Research Center for Environmental Science [Test method] The number of bacteria is measured after direct exposure in an approximately 25m² sized airtight test room (Inhibition method) nanoe™ released [Test substance] Airborne bacteria [Test result] Inhibited by at least 99.7% in 4 hours (24_0301_1)
⁴ <Airborne virus (bacteriophage Φx174)> [Test org.] Kitasato Research Center for Environmental Science [Test method] The number of virus is measured after direct exposure in an approximately 25m² sized airtight test room (Inhibition method) nanoe™ released [Test substance] Airborne virus [Test result] Inhibited by at least 99.7% in 6 hours (24_0300_1)
⁵ <Adhered bacteria (0157)> [Test org.] Japan Food Research Laboratories [Test method] Measured the number of bacteria adhered to a cloth in an approximately 45L sized airtight test room (Inhibition method) nanoe™ released [Test substance] Adhered bacteria [Test result] Inhibited by at least 99.99% in 1 hour (208120800_001)
⁶ <Adhered virus (Influenza virus H1N1 subtype)> [Test org.] Kitasato Research Center for Environmental Science [Test method] Measured the number of virus adhered to a cloth in an approximately 1m² sized airtight test room (Inhibition method) nanoe™ released [Test substance] Adhered virus [Test result] Inhibited by at least 99.9% in 2 hours (24_0084_1)
⁷ <Airborne mold (Cladosporium)> [Test org.] Japan Food Research Laboratories [Test Method] Measured the number of mold altered in an approximately 23m² sized test room (Inhibition method) nanoe™ released [Test substance] Airborne mold [Test result] Inhibited by at least 99% in 1 hour (205061541-001)
⁸ <Adhered mold (Aspergillus)> [Test org.] Japan Food Research Laboratories [Test Method] Measured the mold adhered to a cloth (Inhibition method) nanoe™ released [Test substance] Adhered mold [Test result] Inhibited by at least 99.5% in 8 hours (11038081001-02)

Research into nanoe™ air improvement technology began more than 20 years ago. The nanoe™ technology has spread to various fields in Japan.

Public transport



JR Kyushu
Cruise trains:
Adopted for the
Seven Stars
in Kyushu

Keihan Railway
Keihan Main Line:
Adopted for
admission-paid
special railcars

KEIO
Keio Line:
Adopted for
new railcar models

JR East
Yamanote line:
Adopted for
E235 series models



Home

• Humidifying air purifiers

• Air conditioners

• Humidifiers

• Clothes drying dehumidifiers

• Fans

Office



• 4-way cassette air conditioners



• Elevators

Hitachi

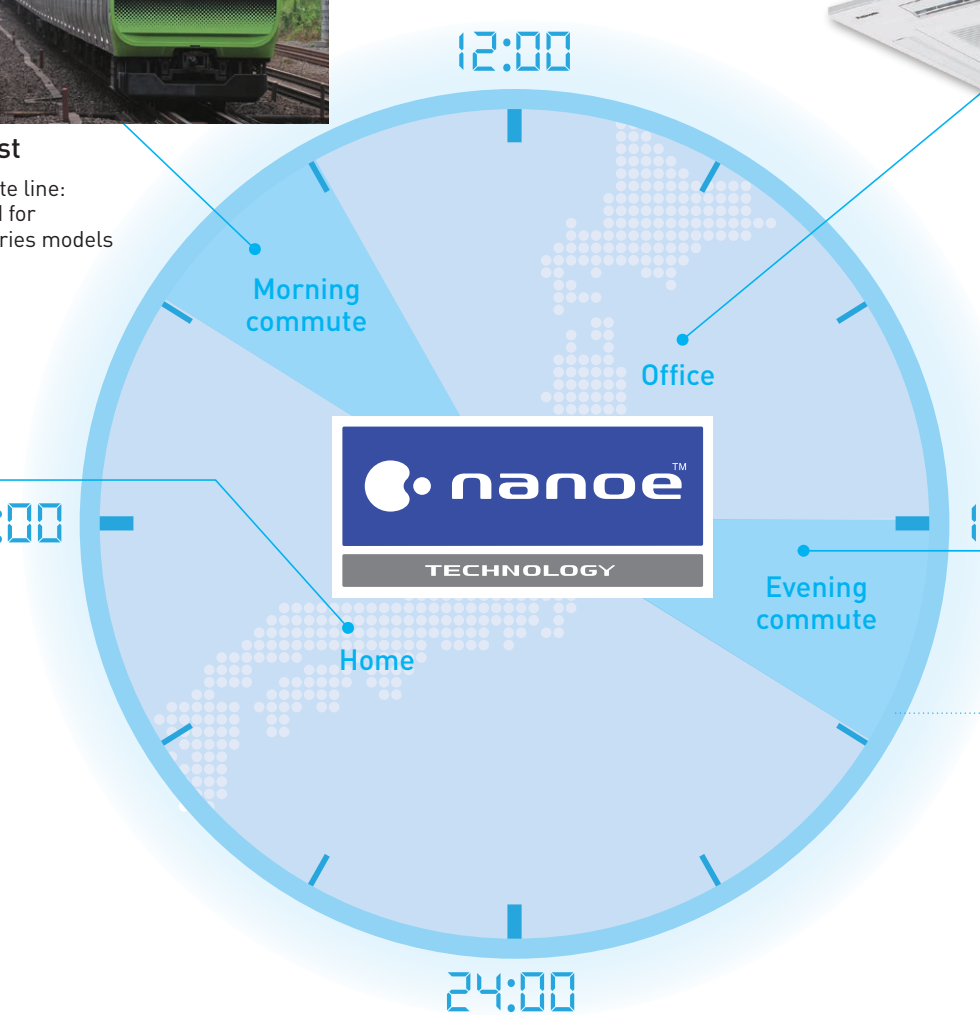

Automotive

Toyota Lexus

Expanding adoption to **40** models



Suzuki

Mazda

Subaru



Public spaces

• Ceiling-embedded nanoe™ generators

Hotels



Hiroshima Washington Hotel



Parkside Hotel

Cafes



Cafe Doll

Hospitals



Sakana Machi Hospital

Nursery schools



Ayumi Nursery School

Nursing homes



Samukawa Nursing Home

Panasonic is committed to the improvement of air quality with nanoe™ Technology.

Trade names, trademarks, and images of products/services are used in this material under approval by the entities concerned in Japan (as of May 31st, 2020).

Built-in Wi-Fi with Panasonic Control App: Convenient centralized control



Advanced smartphone control for ClimaPure XE series

Control air source heat pump operation with Panasonic Control App plus additional functions only available through the Cloud from wherever and whenever. One user can manage up to 200 units and also set up different user rights. Also, energy monitoring is possible allowing opportunity to learn how to reduce the operating cost even more.

1 Smart Control

In control of cooling and heating comfort anytime, anywhere.

Connect & control operation

- 20 units per location and up to 10 different locations
- Transform multiple remote controls into one device

Manage multiple units at once

- Turn on all AC units at the same time or by group settings
- Set weekly timers for multiple units to cater to your daily routines

2 Smart Comfort

Easily manage your comfort and air quality.

Adjust set temperature

Set temperature by monitoring real time indoor and outdoor temperatures.

Pre-heat or cool.

Control your house or office comfort before you arrive!

nanoe™ X¹

Activate nanoe™ X, the advanced technology to deodorize and create healthier environment.

3 Smart Efficiency

More comfort with less wasted energy.

Energy usage analysis²

Monitor energy consumption based on different temperature settings.

Energy usage comparison (day/week/month/year)

Compare energy usage history of AC units for better budget planning.

4 Smart Assist

Be informed of breakdowns.

Error codes notification and identification³

Launch the App to check error codes for effortless troubleshooting. Help technicians to easily identify the issues.

User's control right

Register multiple users. Set administrator rights and assign users access.

1) nanoe™ X is available in certain series.

2) Estimated energy consumption data accuracy depends on power supply quantity.

3) Contact trained technicians to perform any repairing/service.

Easily control and access all features of remote control anytime, anywhere.

New possibilities, new applications

Families: Different users can be set up, such as each child can manage their own room. In second homes, rooms can be remotely pre-cooled or pre-warmed, or turned off if needed.

Multi tenant owner: The ability to manage up to 200 units with just one smartphone. It allows for quick and efficient maintenance through remote error codes and the knowledge of consumption.

Small and medium sized offices: Owner can control different rooms of the office easily and give unit by unit access to their staff. Also provides information to know where energy might be wasted for heating and cooling and promoting best comfort practices.

Smart control at your fingertips

With Panasonic Control App, the user can manage all functions of the heat pump such as nanoe™ X, air flow direction, speed, temperature setting, mode, plus more.

Scalability and users management

Easy to include additional units and locations, as well as the ability to include several users with different access rights. This creates more possibilities to manage the family home, a second house and also provides opportunities for small/medium sized offices or multi-tenant properties.

Energy monitor and statistics

Knowing the energy each unit uses when operating is key to see opportunities to reduce the energy bill. The Panasonic Control App stores the energy consumption* of each unit, which can then be shown in easy and powerful statistics graphs.

With the weekly timer the operation can be adjusted to optimize the usage of the energy.

*Estimated energy consumption data accuracy depends on power supply quality.

Connection Diagram to Panasonic Control App

Indoor Unit

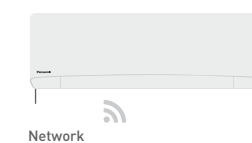

Network

Panasonic Built-in WLAN module

Other hardware requirements (purchase and subscribe separately).



Router Internet Smartphone

Panasonic Cloud Server is designed, operated and managed by Panasonic.

Download free App



Search for "Panasonic Comfort"

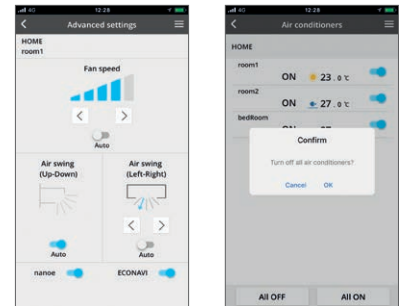

New voice control. Words do more than actions.



Operate the air with your voice

Enjoy the convenience of accessing these four basic operations with just your voice.*

*Functionality is available for ClimaPure™ CS-XE*WKUA model series. See us.panasonic.com/hvac.

1 Turn on/off air conditioner

Convenient control for blissful rest.

Turn on/off AC with ease when preparing a comfortable space for your little ones.

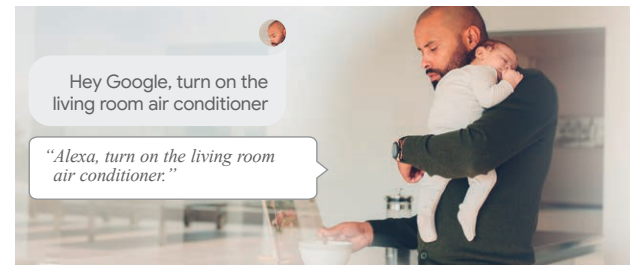

3 Adjust temperature

Easy control for uninterrupted quality time.

Adjust AC temperature to your comfort with a simple voice command.

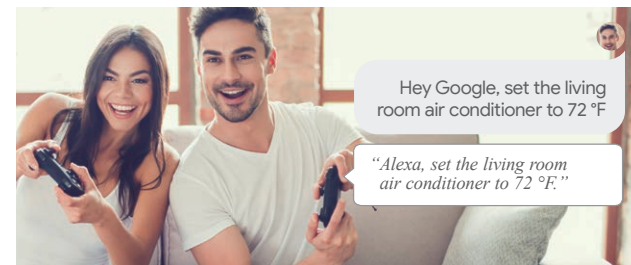

2 Change mode

Extra help when you have a hectic day.

Conveniently change your AC operation mode to cool / heat / auto when your hands are full.



4 Check current status

Hands-free comfort for the whole family.

Easy access for the elderly to check current AC operation status and adjust AC settings.



Control without boundaries and get hands-free help to fully access the features of your air conditioners. Maximising your cooling comfort is now a breeze with our Network-Enabled air conditioners with Panasonic Control App and voice control.



Get multiple things done with your voice

Simplify your day with your personalized routine by grouping individual actions.

Schedule your routine with your voice

With the routine function, you can customize voice commands and control multiple voice-controlled devices including our network-enabled air conditioners to help you with your personalized routine.

"Hey Google, Good morning"

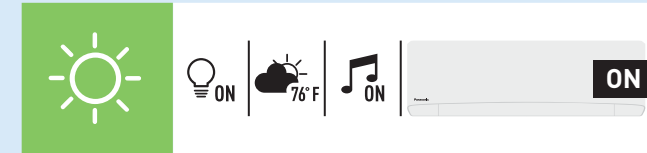

"Hey Google, Good night"



Find out more: [Google] <https://support.google.com/googlehome/answer/7029585?co=GENIE.Platform%3DAndroid&hl=en&oco=0>
[Amazon] <https://www.techhive.com/article/3327501/how-to-use-alexa-routines.html>

Voice control with Network-Enabled air conditioners

Functions	When you are home		When away from home
	Remote Control	Voice Control	Panasonic Control App
Smart control	Power ON/OFF		
	Control multiple AC units in 1 location	—	—
	Control multiple units in multiple locations	—	—
	Set up and manage routines	—	—
Smart comfort	Cooling mode		
	Heating mode		
	Auto mode		
	nanoe™ X mode	—	—
Smart efficiency	Pre-cool	—	—
	Change temperature		
	Analyse energy usage patterns	—	—
	Compare historical usage	—	—
Smart assist	Receive error notifications	—	—
	Assign multiple users		
	Check power ON/OFF		
	Check current mode		
	Check temperature settings		
	Check room temperature		

Compatible device and browsers as of March 2020

1. Android™ 4.4 KitKat® or above
2. iOS 9.0 or above

Please note:

- This is not a definitive list of all compatible devices, other similar devices which use supported Operating Systems should also work either via dedicated Apps. Please note that user experience may vary slightly depending on hardware and software combination
- Google, Android, Google Play, and Google Home are trademarks of Google LLC. KitKat is a registered trademark from Nestlé S.A.
- Amazon, Alexa and all related logos are trademarks of Amazon.com, Inc. or its affiliates
- Availability of Voice Assistant services varies depending on country and language
- More information about set up procedures: <https://aircon.panasonic.com/connectivity/application.html>

How to setup

To sync with your voice assistant, first the AC unit has to be registered in Panasonic Control App.

How to sync Panasonic Control App with the Google Home.

1. Open the Google Home App.
2. Tap "Account".
3. Choose "Set up or add".
4. Choose "Set up device".
5. Choose "Works with Google; Have something already set up?".
6. Search for "Panasonic Comfort".
7. Insert your "Panasonic Comfort" username and password.

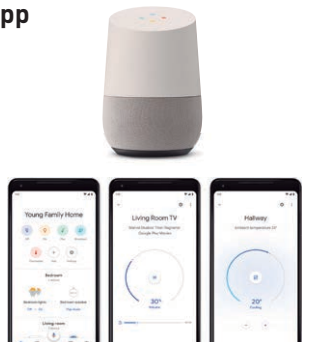

How to sync Panasonic Control App with the Amazon Alexa.

1. Open the Amazon Alexa App.
2. Tap "Devices".
3. Choose "Your Smart Home Skills".
4. Choose "Enable Smart Home Skills".
5. Search for "Panasonic Comfort".
6. Insert your "Panasonic Comfort" username and password.

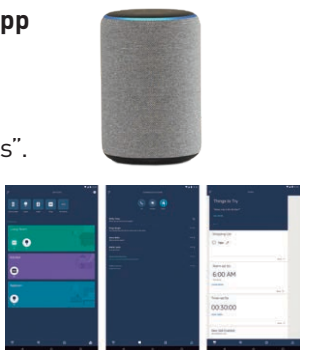

Rugged design that continues to operate high performance even in cold climate of -15°F

PRECISE

Precise design

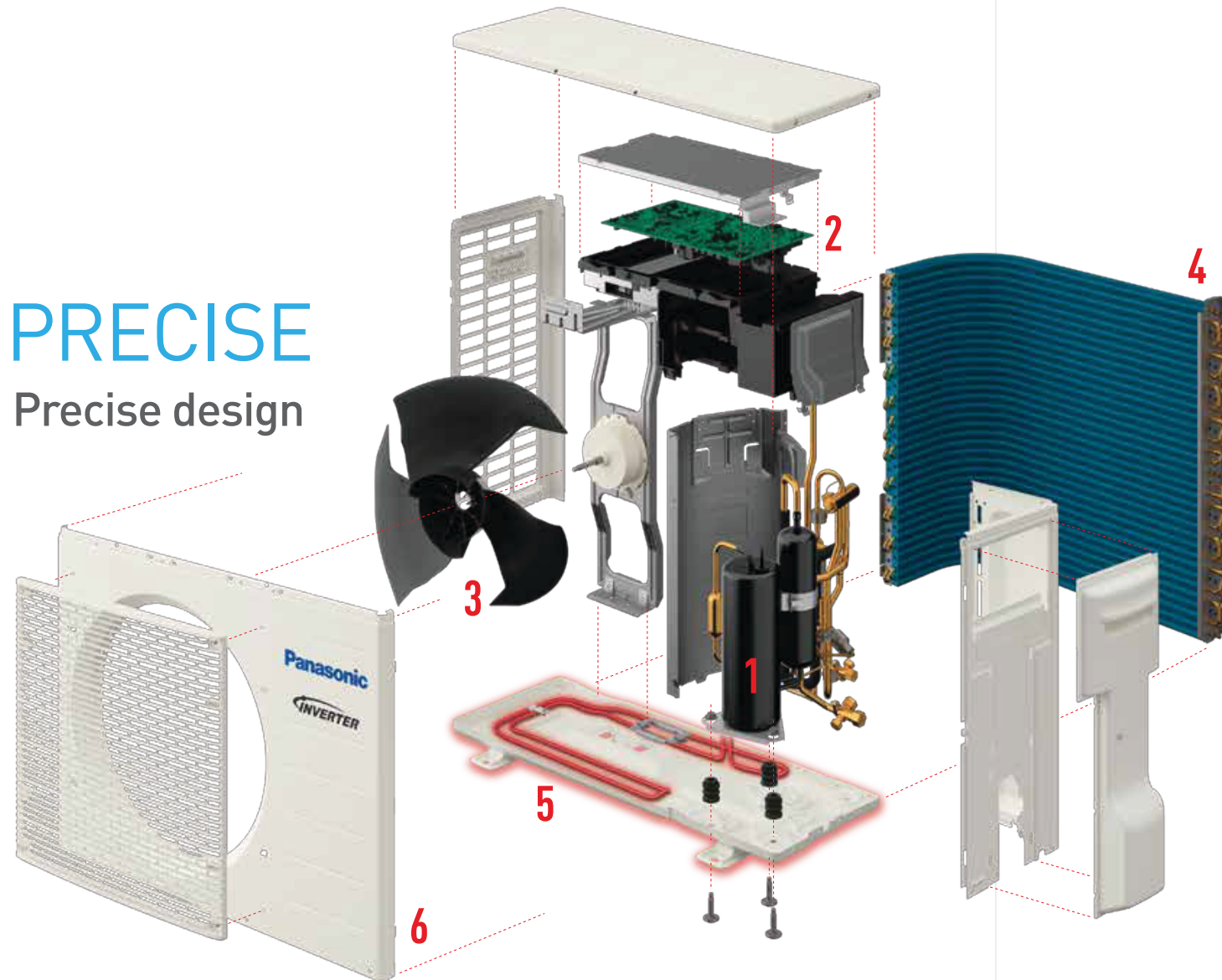

Components arranged in an orderly manner are proof of high-precision and careful finishing. The compressor, which is the heart of the air conditioner, is wrapped in insulation to provide soundproofing and reduce condensation.

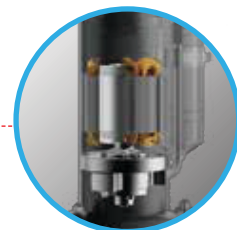

1 High-Efficiency Compressor

High-performance compressor with wide power output range operates accurately with less than 1 ampere for precise operation.

Low Vibration

Anti-vibration rubber mounts on the compressor legs absorb impact and improves durability.



2 Inverter Technology

Advanced drive technology adjusts precise compressor motor rotation. During the start-up phase, the compressor quickly provides powerful, high-speed rotation; during the run phase the compressor smoothly shifts to a low speed rotation for energy savings. This maximizes compressor performance and optimizes high efficient operation.

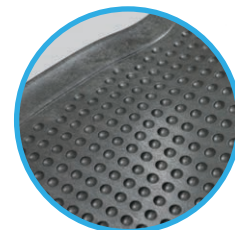

3 High-Efficiency Blades

Frost on heat exchanger is frequent in cold climates. The three blade, high static pressure design moves air quietly and evenly even under harsh conditions and provides high-efficiency operation.

Quiet

Smooth rotation and low vibration ensure quiet operation and durability.

Silicone Coating

The brains of the air conditioner, printed circuit board is coated with silicone to prevent malfunction from insulation deterioration.



TOUGHNESS

Precise design

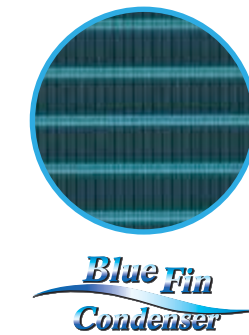

4 Blue Fin Condenser

Blue Fin anti-rust coating is applied to each fin. This special coating prevents rust from salt air and moisture from rain and melting snow and assures longer life of the heat exchanger.

3 layer structure 3 times longer lasting

Note: According to Panasonic test results.

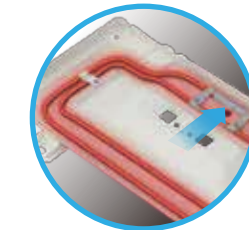
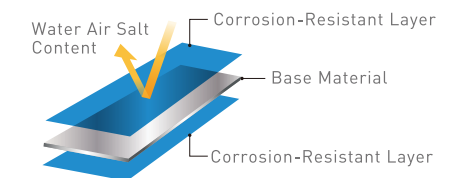

5 Base Pan Heater/ Multiple Drain Ports

A heating element placed around the base pan prevents freezing condensate inside the outdoor unit. Multiple drain holes assist prompt drainage.

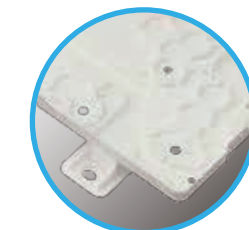

6 Powder Coated Finish

An industrial grade paint used on exterior finishes for guardrails, automobile parts provide corrosion resistance and durability.

Reliability and exceptional quality with over 200 quality assurance tests



Durability

A rugged design ensures that the air conditioners will continue to keep the room comfortable, and provide reliable operation for many years. Panasonic believes this is the true value of an air conditioner and the reason we subject them to a wide range of stringent durability tests.

- Long-term Durability Test
- Compressor Reliability Test
- Operating Test in Harsh Conditions
- Waterproof Test

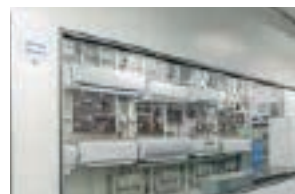

Panasonic conduct tests under conditions that are much more severe than actual operating conditions.



The outdoor unit is provided with IPX4 waterproof compliance. Also, an operating durability test has been conducted at a temperature up to 130°F down to -13°F in test chamber.



Shock Resistance

Panasonic simulates impacts, vibrations and other external conditions that air conditioners might receive during transportation. We assure that the quality and performance at the time of the final product inspection are maintained when the product reaches the user's home.

- Drop Test
- Vibration Test
- Warehouse Stacking Test



Even with the large impacts during transportation, the product packaging has been strengthened to prevent it from being damaged.



We place a weight on top of the test package and leave it in a room at high-temperature and humidity. After this warehouse simulation test, the product is checked for proper operation.



Comfort

Air conditioners should keep each person in the room comfortable without making their presence known. They should work totally in the background, using their strength to create and maintain a comfortable environment. We build this hidden strength into our air conditioners, and test them repeatedly from this viewpoint.

- Noise Test
- Environmental Test
- EMC (Electromagnetic Compatibility) Test
- Remote Control Usability Test



An actual air conditioner is operated in a test room that simulates a standard living room. The test makes it possible to confirm optimum performance level under ever-changing conditions.



A variety of tests are conducted to judge the visibility of the button colors, operating ease. The remote control is also subjected to a 1.5-meter dropping test from various angles.

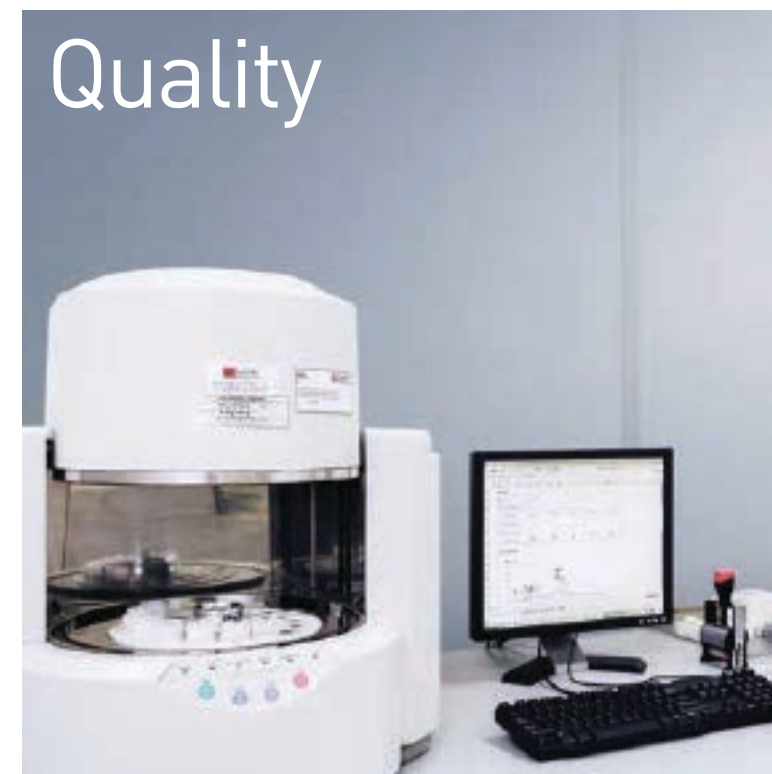

Quality

Panasonic continues to offer the highest quality with the lowest possible environment impact. The fundamental principles of Panasonic products naturally apply to air conditioners. In order to live up to our reputation for quality, we work to overcome challenges and devote maximum efforts all over the world.

- International Standard Quality
- Sophisticated Production Process



Panasonic air conditioners comply with all necessary leading industrial standards and regulations required for the market in each country.



Panasonic factories reduce CO2 emissions and conduct regional-based environmental communication activities to contribute to both the global environment and the local communities.

With Panasonic, heating and cooling are all-in-one providing year-round comfort

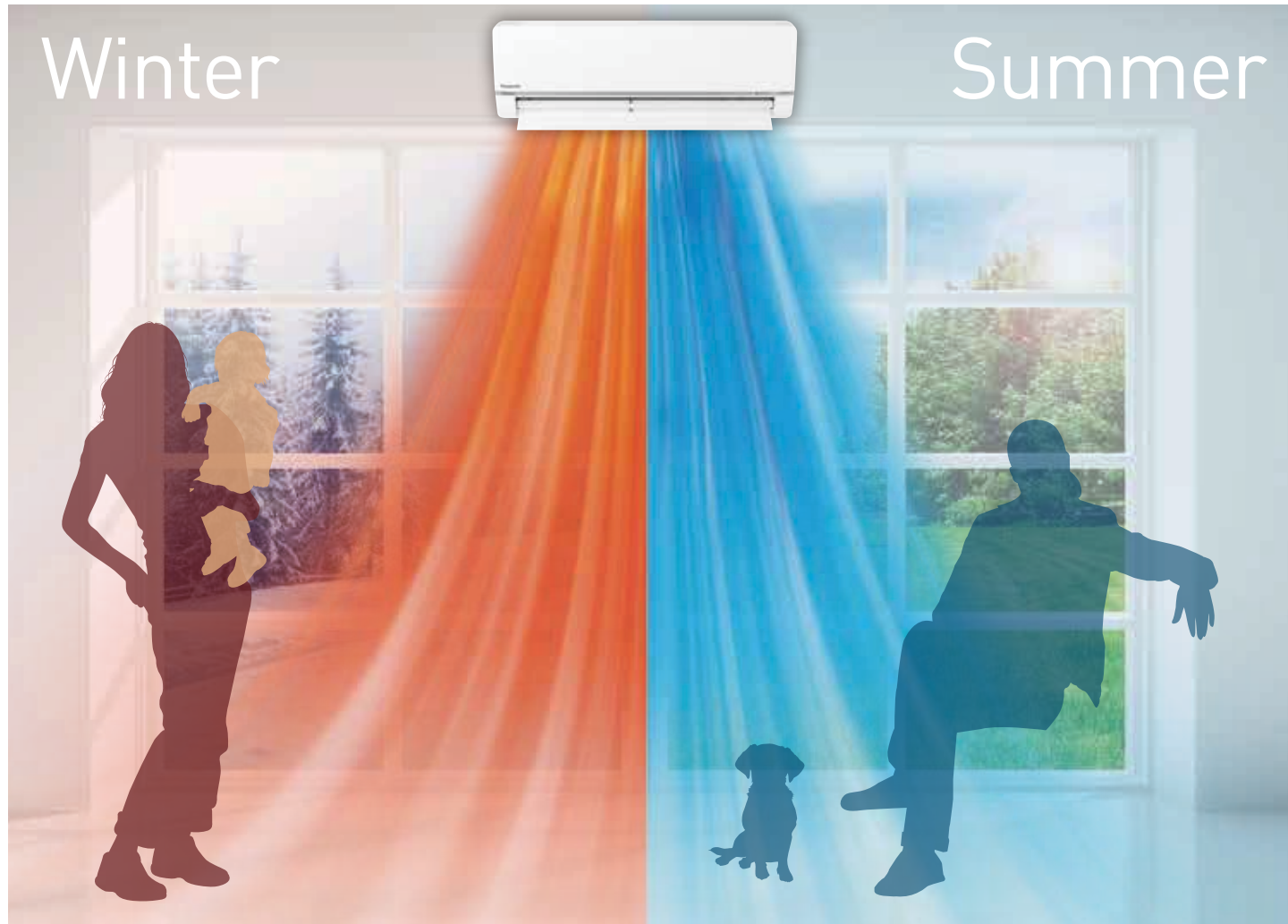

All seasons YEAR-ROUND USE

The air conditioning heat pump consists of a single or multiple indoor units and a single outdoor condenser unit. The indoor and outdoor units are connected by refrigerant pipes that cycle refrigerant gas between the indoor and outdoor units. The direction of the gas can be switched which changes operation between heating and cooling. This switching change is done with a simple button push on the remote controller and heating and cooling comfort is provided year-round.



At heating operation Simply said, heat is transferred from outdoors to indoors using a compressor and high pressure, high temperature refrigerant. Cool air is drawn into the indoor unit and Warm air is released into the room. The refrigerant cycle continually repeats.

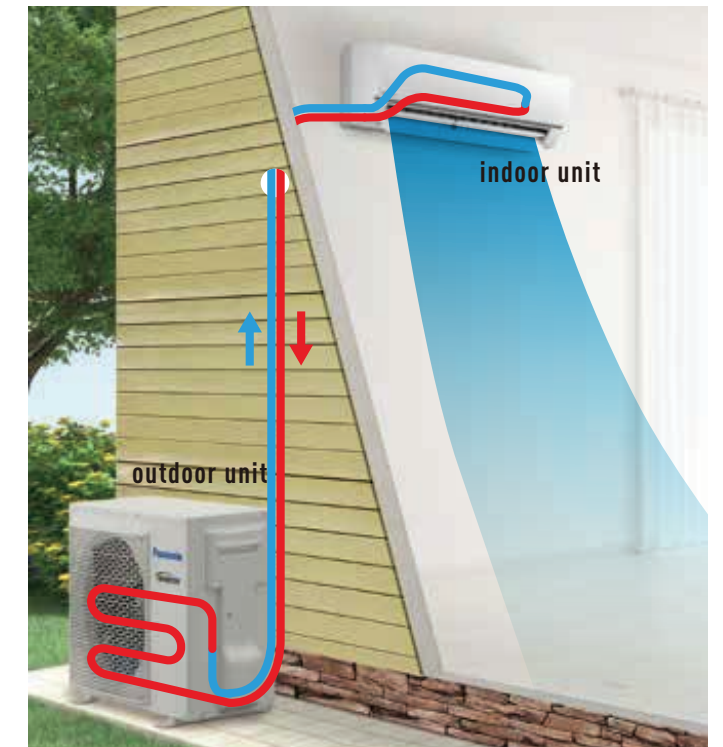

At cooling operation Simply said, heat is transferred from indoors to outdoors using a compressor and high pressure, high temperature refrigerant in a reverse cycle from heating. Warm moist air is drawn into the indoor unit and Cool dry air is released into the room. The refrigerant cycle continually repeats.

Superb comfort PRECISE CONTROL

Panasonic inverter technology continually adjusts its compressor rotation speed to provide maximum performance at all times. This precise operation enables quick cooling or heating while reducing power consumption compared to conventional non-inverter units.



Reduces Electricity Consumption

Panasonic inverter air conditioners/heat pumps are designed to give you exceptional energy savings while ensuring you stay comfortable at all times.



Constant Comfort

Precise temperature control with a wide power output range enables an Inverter air conditioner/heat pump to meet different room occupancy levels, providing constant comfort.



Quick Cooling and Heating

Panasonic Inverter air conditioner/heat pump can operate with higher cooling/heating power the room faster than non-inverter models.



Whisper Quiet Operation

The indoor operating noise has been reduced by 5dB as the Inverter constantly varies its output power to enable more precise temperature control.

Advanced Inverter & ECONAVI Technology

Optimum Performance while reducing Energy Usage

Panasonic inverter technology constantly adjusts its compressor rotation speed to provide maximum performance at all times. This precise operation enables quick cooling or heating while reducing power consumption compared to conventional non-inverter units.

Reduces Electricity Consumption

Panasonic inverter air conditioners/heat pumps are designed to give you exceptional energy savings while ensuring you stay comfortable at all times.

Constant Comfort

Precise temperature control with a wide power output range enables an inverter air conditioner to meet different room occupancy levels, providing constant comfort.

Quick Cooling and Heating

Panasonic Inverter air conditioners can operate with higher cooling/heating power during the start-up period to cool/heat the room faster than non-inverter models.

Whisper Quiet Operation

The indoor operating noise has been reduced by 5dB as the Inverter constantly varies its output power to enable more precise temperature control.

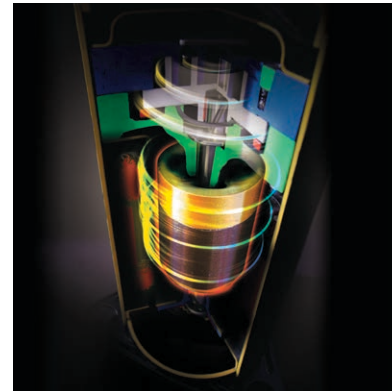

• Wider Output Power Range

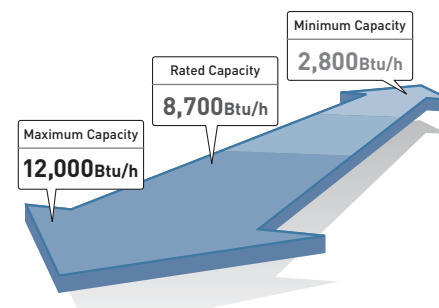

What's ECONAVI?

High-precision sensor technology allows efficient, automatic operation to match room conditions. This keeps everyone comfortable while saving energy.

What does ECONAVI detect?

EXAMINE	<ul style="list-style-type: none"> • Level of activity. • Human presence.
EVALUATE	<ul style="list-style-type: none"> • Changes in human activity. • Changes in human presence.
EXECUTE	<ul style="list-style-type: none"> • Low activity: Auto increase set temperature. • Absence: Auto increase set temperature.



Advanced ECONAVI Technology

Energy Saving and Comfort through Sensor Technology



ECONAVI SENSOR

1. Absence Detection Human Activity Sensor

Reduces energy usage when no activity is detected.

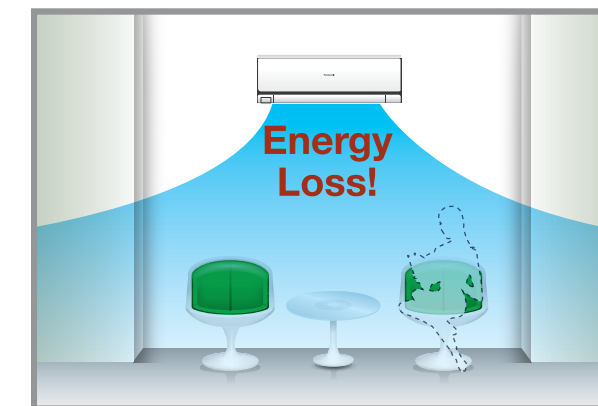

Switches from high operation to reduce cooling.

2. Activity Detection Human Activity Sensor

When activity is detected, sensors start working to efficiently cool the zone.



Switches from high to mild cooling.

Air Conditioner and Heat Pump Line-Up

Your Best Choice in Mini Split Air Conditioning and Heat Pump Systems

Since 1983, Panasonic Mini Split Air Conditioner and Heat Pump products offer a wide range of versatile solutions for cooling and heating requirements for single or multiple rooms. The indoor unit (evaporator) is mounted inside a room and connected to the outdoor unit (condenser) via refrigerant lines and inter-unit wiring through a 3-1/2" opening in the wall. Since no ductwork is required, installation is simple, fast and efficient. Ducted models are also available.

The indoor unit has been uniquely designed to provide whisper-quiet operation while delivering comfort throughout the room. Panasonic Mini Split Systems are stylish and provide the quality and reliability you can count on.

MULTI-ZONE: Residential and Light Commercial Applications

MULTI SPLIT HEAT PUMPS						
Zones		2	2 thru 3	2 thru 4	2 thru 5	
System Btu/h		18,000 (1.5 TON)	19,000 (1.5 TON)	24,000 (2.0 TON)	36,000 (3.0 TON)	
SEER (Non-Ducted / Ducted)		19.0 / 19.0	22.0 / 18.5	22.0 / 19.0	18.5 / 16.5	
HSPF (Non-Ducted / Ducted)		9.5 / 9.0	10.5 / 9.0	9.5 / 9.0	10.0 / 9.5	
Outdoor Unit		 CU-2E18SBU-5	 CU-3E19RBU-5	 CU-4E24RBU-5	 CU-5E36QBU-5	
Indoor Unit	Wall Mount 5,000 Btu/h	 CS-ME5RKUA	CS-ME5RKUA	CS-ME5RKUA	CS-ME5RKUA	
	Wall Mount 7,000 Btu/h	 CS-ME7RKUA	CS-ME7RKUA	CS-ME7RKUA	CS-ME7RKUA	
	Wall Mount 9,000 Btu/h	 CS-E9RKUAW	CS-E9RKUAW CS-XE9WKUA	CS-E9RKUAW	CS-E9RKUAW	
	Wall Mount 12,000 Btu/h	 CS-E12RKUAW	CS-E12RKUAW CS-XE12WKUAW	CS-E12RKUAW	CS-E12RKUAW	
	Wall Mount 15,000 Btu/h	N/A	CS-XE15WKUAW	N/A	N/A	
	Wall Mount 18,000 Btu/h	N/A	CS-E18RKUAW CS-XE18WKUAW	CS-E18RKUAW	CS-E18RKUAW	
	Wall Mount 24,000 Btu/h	N/A	N/A	CS-E24RKUAW	CS-E24RKUAW	
	4-Way Cassette 9,000 Btu/h	 CS-ME9SB4U	CS-ME9SB4U	CS-ME9SB4U	CS-ME9SB4U	
	4-Way Cassette 12,000 Btu/h	 CS-E12RB4UW	CS-E12RB4UW	CS-E12RB4UW	CS-E12RB4UW	
	4-Way Cassette 18,000 Btu/h	N/A	CS-E18RB4UW	CS-E18RB4UW	CS-E18RB4UW	
	Slim Duct 5,000 Btu/h	 CS-ME5SD3UA	CS-ME5SD3UA	CS-ME5SD3UA	CS-ME5SD3UA	
	Slim Duct 7,000 Btu/h	 CS-ME7SD3UA	CS-ME7SD3UA	CS-ME7SD3UA	CS-ME7SD3UA	
	Slim Duct 9,000 Btu/h	 CS-E9SD3UAW	CS-E9SD3UAW	CS-E9SD3UAW	CS-E9SD3UAW	
	Slim Duct 12,000 Btu/h	 CS-E12SD3UAW	CS-E12SD3UAW	CS-E12SD3UAW	CS-E12SD3UAW	
Slim Duct 18,000 Btu/h	N/A	CS-E18SD3UAW	CS-E18SD3UAW	CS-E18SD3UAW		

All Multi-Zone Systems require a minimum 2 indoor units installed.
When selecting Multi-Zone please consider System Capacity and Indoor Unit Combinations. See pages 42 and 43.

SINGLE ZONE: Residential and Light Commercial Applications

RESIDENTIAL								
System Btu/h				9,000	12,000	15,000	18,000	24,000
ClimaPure™ XE -15F Degree	Up To 28.2 SEER 14.5 HSPF	Outdoor Unit	 CU-XE9WKUA	CU-XE12WKUA	CU-XE15WKUA	CU-XE18WKUA	CU-XE24WKUA	
		Wall Mount	 CS-XE9WKUAW	CS-XE12WKUAW	CS-XE15WKUAW	CS-XE18WKUAW	CS-XE24WKUAW	
EXTERIOS® -5 Degree	Up to 23.0 SEER 11.0 HSPF	Outdoor Unit	 CU-E9RKUA	CU-E12RKUA	N/A	CU-E18RKUA	CU-E24RKUA	
		Wall Mount	 CS-E9RKUAW	CS-E12RKUAW	N/A	CS-E18RKUAW	CS-E24RKUAW	
Pro Series -5 Degree	Up to 16 SEER 8.5 HSPF	Outdoor Unit	 CU-RE9SKUA	CU-RE12SKUA	N/A	CU-RE18SKUA	CU-RE24SKUA	
		Wall Mount	 CS-RE9SKUA	CS-RE12SKUA	N/A	CS-RE18SKUA	CS-RE24SKUA	
Pro Series 115 volt -13F Degree	Up to 20.0 SEER 10.5 HSPF	Outdoor Unit	 CU-YE9WKU1	CU-YE12WKU1	N/A	N/A	N/A	
		Wall Mount	 CS-YE9WKU1	CS-YE12WKU1	N/A	N/A	N/A	
4-Way Ceiling 5 Degree	Up to 18.0 SEER 9.0 HSPF	Outdoor Unit	N/A	CU-E12RB4U	N/A	CU-E18RB4U	N/A	
		4-Way Cassette	 CS-E12RB4UW	N/A	CS-E18RB4UW	N/A	CS-E18RB4UW	N/A
Ducted -5 Degree	Up to 20.5 SEER 10.0 HSPF	Outdoor Unit	 CU-E9SD3UA	CU-E12SD3UA	N/A	CU-E18SD3UA	N/A	
		Ducted	 CS-E9SD3UAW	CS-E12SD3UA	N/A	CS-E18SD3UA	N/A	

Representative product images shown here. See product page for actual model images.

Model Feature Chart

		HEAT PUMPS					
		XE9WKUA XE12WKUA XE15WKUA XE18WKUA XE24WKUA	E9RKUA E12RKUA E18RKUA E24RKUA	RE9SKUA RE12SKUA RE18SKUA RE24SKUA	YE9WKU1 YE12WKU1 (115v)		
	Wall Mounted						
	4-Way Cassette						E12RB4U E18RB4U
	Ducted					E9SD3UAW E12SD3UAW E18SD3UAW	
	nanoe™ X Purification System	✓					
	Wi-Fi	Built-in	Option			Option	Option
	Auxiliary Heat Connect	✓					
	ECONAVI Sensor		✓				
	Dry Mode	✓	✓	✓		✓	✓
	Blue Fin Condenser	✓	✓	✓		✓	
	Room Freeze Protection	✓					
	Microprocessor-Controlled Operation	✓	✓	✓		✓	✓
	Wireless Remote Controller	✓	✓	✓	✓	✓	✓
	Wired Remote Controller	Option	Option	Option		Option	Option
	Self-Diagnosing Function	✓	✓	✓	✓	✓	✓
	5 Fan Speeds and Automatic Fan Operation	✓	✓	✓	✓	✓	✓
	Air Sweep Control	✓	✓	✓		✓	✓
	Louver Control	✓	✓	✓		✓	✓
	Base Pan Heater	✓			✓		
	Automatic Heating and Cooling Changeover	✓	✓	✓	✓	✓	✓
	Hot Start Heating System	✓	✓	✓		✓	✓
	24-Hour Clock with ON/OFF Program Timer	✓	✓	✓	✓	✓	✓
	1-Hour OFF Timer				✓		
	Weekly Timer	Option	Option			Option	Option
	Filter Sign	Option	Option			Option	Option
	Automatic Restart Function after Power Failure	✓	✓	✓	✓	✓	✓
	Built-In Drain Pump					✓	✓
	Low Ambient	✓	✓	✓		✓	✓
	Electric Expansion Valve	✓	✓	✓	✓	✓	✓
	R-410A Refrigerant	✓	✓	✓	✓	✓	✓
	Quiet Mode	✓	✓	✓		✓	✓
	PM2.5 Filter (option)	✓					
	Anti-Microbial Filter (option)	✓	✓	✓			

Features

nanoe™ X Air Purification System

Advanced nanoe™ X air purification technology with no maintenance required. (See pages 4-9)

Wi-Fi Options

Control heating and air conditioning through easy-to-use smartphone app.

- XE with Built-in Wi-Fi (See pages 10, 11, 52)
- Other models optional Wi-Fi adapter (See page 53)

Auxiliary Heat Connect

Optional auxiliary heater connection kit to turn on/off an auxiliary heater device during extreme low ambient conditions.

ECONAVI Sensor

Automatic sensor for energy efficiency and comfort. Absence & Activity Detection, Area Search

Dry Mode

By coupling compressor and fan operation, intermittent operation can be precisely controlled according to room temperature, so that air is efficiently dehumidified.

Blue Fin Condenser

Condensers can take a beating from exposure to salty air, rain and other corrosive factors. Panasonic has extended the life of its condensers with an original anti-rust coating.

Tested for 2,000 salt spray hours.

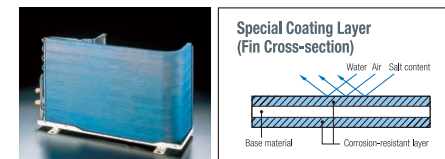

Room Freeze Protection*

Room Freeze Protection mode helps prevent plumbing damage due to sub-Freezing Temperature. This mode automatically turns on the compressor for heat pump operation if the room temperature falls to about 46°F.

*This function may not be performed if the unit is not powered, or if the unit is unable to operate such as in protection mode. Please consult with the HVAC installers or professional for details.

Microprocessor-Controlled Operation

Microprocessor control ensures that the temperature and humidity levels in the room are comfortable.

Wireless Remote Control

Panasonic's infrared Remote Control with an easy-to-read LCD Display, gives the user the capability to adjust & set: temperature, sweep (louver control), fan speeds, timer and more, for complete automatic operation.

Self-Diagnosing Function

Units are equipped with Self-Diagnosing Function (methods are different depending on the models). This makes it easier to diagnose malfunctions, greatly reducing service labor (Wired remote controller).



5 Fan Speeds and Automatic Fan Operation

Convenient microprocessor control automatically adjusts fan speed to High, Medium or Low, according to room temperature to maintain a comfortable airflow throughout the room.

Air Sweep Control

The air sweep function moves the louver up and down in the air outlet, directing air in a "sweeping" motion around the room.

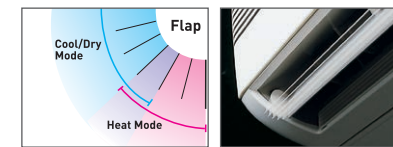

Base Pan Heater

Exterios XE models include a base pan heater that helps prevent freezing condensate and allows very low ambient operation.

Automatic Heating and Cooling Changeover

After setting the temperature and functions you desire, just relax. If the room temperature is higher than the set temperature, cooling operation begins. If the room temperature is lower than the set temperature, heating operation begins. During normal thermostat cycle operation, cooling and heating operations automatically change in accordance with set temperature, time and room temperature (Single Zone Heat Pump unit only).

Hot Start Heating System

Right from the start, air is warm and comfortable. The Hot Start Heating System helps prevent any cold blasts at the beginning while the heat pump is warming up (Heat pump unit only).

24-hour Clock with ON/OFF Program Timer

The remote control unit allows you to set a wide variety of timer-based operations. Such functions include automatic ON/OFF with a timer setting, same time ON/OFF every day, ON timer, OFF timer and Combination timer.

1-hour OFF Timer

When this button is pushed either while the unit is operating or while it is stopped, the unit will operate for one hour, then switch off automatically.

Filter Sign

Filter sign informs you when filter maintenance is necessary.

XE/E series with CZ-RD516C-1



Automatic Restart Function after Power Failure

Built-In Drain Pump

Max. head 20 inches from the discharge of the indoor unit. Condensation pump is only for allowing drain line to meet minimum gravity flow requirements.

Low Ambient

Low Ambient heating operation models range from 5°F to -15°F

Electric Refrigerant Control Valve

The circulation volume of the refrigerant is controlled by a pulse type electric control valve. In order to attain optimum efficiency, when the power is switched ON, the opening degree of the electric control valve is controlled between 90 and 480 steps.

Quiet Mode

LOW, low fan speed for extra quiet operation.

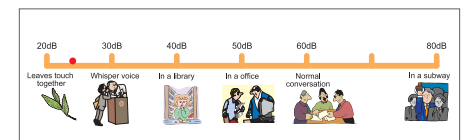

Stage 2 Filter

PM2.5 to inhibit up to 90% of dust particles.

Anti-Microbial treated to inhibit the growth of mold and mildew.

Test Comparison

	Microbial Growth Rating	
	7 days	28days
Anti-microbial Filter	No growth	No growth
Normal Filter Paper	60% growth	60% growth

*Tested per ASTM G21-96 equivalent

The latest breakthrough in energy efficiency and high performance

ClimaPure™ XE



**WALL MOUNTED HEAT PUMP
COLD CLIMATE SERIES**

The new ClimaPure™ XE ductless heating and air conditioning system features nanoe™ X — a built-in air and surface purification technology that provides a comfortable environment for occupants by reducing pollutants and odors. nanoe™ X penetrates deep into the fibers of carpets and furniture to inhibit pollutants and odors. Featuring whisper-quiet heating and cooling and advanced built-in air purification technology, the XE series sets a new standard for a comfortable indoor environment.



Low Ambient Heating -15°F

Operational heat capacity down to -15°F provides heating in extreme cold regions. Low Ambient performance specifications qualifies ClimaPure™ XE series for most air source heat pump rebate programs.



nanoe™ X Air and Surface Purification

nanoe™ X generates large quantities of hydroxyl radicals that are distributed throughout the room to reduce air and surface pollutants and odors resulting in a cleaner living environment. See pages 4-9. ClimaPure™ XE series also offers an optional CZ-SA31P filter to further reduce PM2.5.

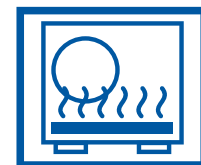

Base Pan Heater

Base Pan Heater is included with ClimaPure™ XE models and operates during defrost cycles to help prevent frozen condensate. Multiple drain holes to help prevent frozen condensate build up.



Built-in Wi-Fi with Panasonic Control App

Manage all function of the mini-split from any location using ClimaPure™ XE series Built-in Wi-Fi with Panasonic Control App. Set up user rights to manage scalability up to 200 units in 10 locations.

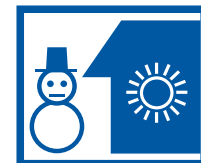

Room Freeze Protection

Helps prevent plumbing damage due to sub-freezing temperatures. Automatically turns on compressor for heat pump operation if the room temperature falls below 46°F.



High Energy Efficiency

Provides high energy efficiency up to 28.2 SEER, 14.5 HSPF which reduces operating costs.



Inverter Technology

Panasonic inverter technology provides optimum power control and extremely efficient operation by modulating the compressor capacity. The result is efficient and flexible operation using less electricity.



Blue Fin Condenser

Condensers can take a beating from exposure to salty air, rain and other corrosive factors. Panasonic has extended the life of its condensers with an anti-rust coating.

WALL MOUNTED HEAT PUMP COLD CLIMATE SERIES																	
System		XE9WKUA			XE12WKUA			XE15WKUA			XE18WKUA			XE24WKUA			
Indoor Model		CS-XE9WKUAW			CS-XE12WKUAW			CS-XE15WKUAW			CS-XE18WKUAW			CS-XE24WKUAW			
Outdoor model		CU-XE9WKUA			CU-XE12WKUA			CU-XE15WKUA			CU-XE18WKUA			CU-XE24WKUA			
Low Ambient Heat Operation		-15°F (no lockout)			-15°F (no lockout)			-15°F (no lockout)			-15°F (no lockout)			-15°F (no lockout)			
		MIN	RATED	MAX	MIN	RATED	MAX	MIN	RATED	MAX	MIN	RATED	MAX	MIN	RATED	MAX	
Cooling (Indoor Dry Bulb 80°F)	95°F	BTU/h	2800	8700	12000	2800	11500	14000	3300	14700	19000	5800	17200	19800	5800	24000	27200
	47°F	BTU/h	3000	10900	18000	3000	12000	23000	3300	17200	24000	5800	20400	30000	5800	28800	33800
Heating (Indoor Dry Bulb 70°F)	17°F	COP (W/W)	5.93	4.79	3.21	5.93	4.39	3.73	4.90	4.00	2.65	4.47	3.66	3.14	4.47	3.36	3.30
		BTU/h	8000			10000				11000			14000			18500	
	5°F	BTU/h			11000			12000			17200			20400			25200
	COP			2.30			2.20			2.10			2.30			2.170	
	COP																

SEER	28.20	24.60	21.10	21.00	20.00
EER	16.1	14.15	12.55	13.2	10.9
HSPF Region IV	14.50	13.00	13.00	12.00	10.60
ENERGY STAR®	Yes	Yes	Yes	Yes	N/A
Moisture Removal Volume	Pt/h	1.3	2.5	4.0	3.6
NEEP Tier level		Tier 2	Tier 2	Tier 2	N/A
Base Pan Heater		Included	Included	Included	Included
Auxiliary Heater Connection		AUXHTK1 (optional)	AUXHTK1 (optional)	AUXHTK1 (optional)	AUXHTK1 (optional)
Connectivity		Built-in Wi-Fi plus App	Built-in Wi-Fi plus App	Built-in Wi-Fi plus App	Built-in Wi-Fi plus App
Wireless Controller		Included	Included	Included	Included
Wired Controller		CZ-RD516C-1 (optional)	CZ-RD516C-1 (optional)	CZ-RD516C-1 (optional)	CZ-RD516C-1 (optional)

Noise Cooling	Indoor	dB-A (H/L/Q-Lo)	42	25	20	45	28	20	45	37	34	47	39	36	49	40	37
	Outdoor	dB-A (H/L/Q-Lo)	48	-	-	49	-	-	51	-	-	52	-	-	53	-	-
Noise Heating	Indoor	dB-A (H/L/Q-Lo)	42	29	26	44	35	32	47	37	34	48	39	36	49	40	37
	Outdoor	dB-A (H/L/Q-Lo)	48	-	-	49	-	-	55	-	-	54	-	-	55	-	-

V. Phase, Hz		230/208V, 1PH, 60Hz	230/208V, 1PH, 60Hz	230/208V, 1PH, 60Hz	230/208V, 1PH, 60Hz	230/208V, 1PH, 60Hz
Running Amps	Cooling	Amp	2.6/2.9	3.8/4.2	5.4/6.0	6.2/6.9
	Heating	Amp	3.2/3.6	3.8/4.2	5.8/6.6	7.7/8.7
Power Input	Cooling	Watt	540	810	1170	1300
	Heating	Watt	670	800	1260	2520
Base Pan Heater	Watt	80	80	80	80	80
Min. Circuit Ampacity	Amp	15	15	20	20	25
Max. Overcurrent Protection	Amp	15	20	25	25	30

Advanced Air Purification Features	Evaporator Guard Filter	Included	Included	Included	Included	Included
	PM2.5 (CZ-SA31P)	Optional	Optional	Optional	Optional	Optional
	Anti Microbial (CZ-SA20P)	Optional	Optional	Optional	Optional	Optional
	nanoe™ X Air Purification	Included	Included	Included	Included	Included
Features	Fan Speeds	5 Speeds + Auto	5 Speeds + Auto	5 Speeds + Auto	5 Speeds + Auto	5 Speeds + Auto
	Dry Air Flow	High CFM	380	415	430	560
	Timer	24hr Program	24hr Program	24hr Program	24hr Program	24hr Program
	Air Deflection	Horizontal	Automatic	Automatic	Automatic	Automatic
Vertical		Automatic	Automatic	Automatic	Automatic	Automatic

Inverter Variable Capacity	Yes	Yes	Yes	Yes	Yes		
Refrigerant	R410a	R410a	R410a	R410a	R410a		
Piping	Refrigerant Piping	Type	Flare	Flare	Flare	Flare	Flare
		Discharge inches	1/4"	1/4"	1/4"	1/4"	1/4"
	Suction inches	3/8"	1/2"	1/2"	1/2"	5/8"	
	Refrigerant Pipe Length	Min - Max ft	9.8 - 65.6	9.8 - 65.6	9.8 - 65.6	9.8 - 100	9.8 - 100
		Elevation Difference*	Outdoor Above ft	Max. 49.2	Max. 49.2	Max. 49.2	Max. 49.2
	Outdoor Below ft	Max. 49.2	Max. 49.2	Max. 49.2	Max. 49.2	Max. 49.2	

Unit	Indoor	H/W/D (ft)	11-5/8	34-9/32	9-1/16	11-5/8	34-9/32	9-1/16	11-5/8	34-9/32	9-1/16	11-29/32	43-13/32	9-5/8	11-29/32	43-13/32	9-5/8
	Weight	lb.	24	24	24	24	24	24	24	24	24	33	33	33	33	33	33
	Outdoor	H/W/D (ft)	24-1/2	32-15/32	11-25/32	24-1/2	32-15/32	11-25/32	27-3/8	34-15/32	12-5/8	31-5/16	34-15/32	12-5/8	31-5/16	34-15/32	12-5/8
Carton	Weight	lb.	82	82	82	82	82	82	106	106	106	132	132	132	132	132	132
	Indoor	H/W/D (ft)	10-7/8	37-13/16	14-3/8	10-7/8	37-13/16	14-3/8	10-7/8	37-13/16	14-3/8	11-7/16	46-5/32	14-29/32	11-7/16	46-5/32	14-29/32
	Weight	lb.	26	26	26	26	26	26	26	26	26	37	37	37	37	37	37
	Outdoor	H/W/D (ft)	26-25/32	37-23/32	16-13/32	26-25/32	37-23/32	16-13/32	29-11/32	41-5/16	18-1/8	34-25/32	41-5/16	19-1/8	34-25/32	41-5/16	19-1/8
	Weight	lb.	88	88	88	88	88	88	88	53	53	66	66	66	66	66	66

Important: You must use refrigerant piping rated for R410a.
*This is maximum elevation difference when the indoor unit is located above the outdoor unit. See p. 51 for additional information.

Deluxe E Series Wall-Mounted Heat Pumps EXTERIOS **E**

E9RKUA / E12RKUA		E18RKUA / E24RKUA	
<p>INDOOR UNIT CS-E9RKUAW / CS-E12RKUAW</p>		<p>INDOOR UNIT CS-E18RKUAW / CS-E24RKUAW</p>	
<p>OUTDOOR UNIT CU-E9RKUA / CU-E12RKUA</p>		<p>OUTDOOR UNIT CU-E18RKUA / CU-E24RKUA</p>	

Cooling only operation may be configured during installation.

Pipe diameters listed below are for single zone only. Multi-Zone pipe diameters on page 51.

WALL MOUNT HEAT PUMPS										
Model No.	E9RKUA		E12RKUA		E18RKUA		E24RKUA			
Unit Model No.	Indoor Unit	Outdoor Unit	Indoor Unit	Outdoor Unit	Indoor Unit	Outdoor Unit	Indoor Unit	Outdoor Unit		
	CS-E9RKUAW	CU-E9RKUA	CS-E12RKUAW	CU-E12RKUA	CS-E18RKUAW	CU-E18RKUA	CS-E24RKUAW	CU-E24RKUA		
Performance & Electrical Ratings										
Capacity	Cooling	Btu/h	9,000 (4,100–10,200)	11,500 (4,100–13,300)	17,200 (5,800–19,800)	24,000 (5,800–27,200)				
	Heating	Btu/h	12,000 (4,100–14,100)	13,800 (4,100–16,300)	21,600 (5,800–22,000)	28,800 (5,800–29,200)				
Moisture Removal	High	Pints/H	1.3	1.7	3.0	7.6				
Dry Air Flow	High	CFM	425	450	670	670				
SEER	Cooling		23.0	22.5	19.5	19.0				
EER	Cooling		13.0	12.5	13.2	10.2				
HSPF	Heating		11.0	11.0	10.0	10.0				
Power Supply	V, Phase, Hz		230/208V, 1PH, 60Hz	230/208V, 1PH, 60Hz	230/208V, 1PH, 60Hz	230/208V, 1PH, 60Hz				
Running Amps	Cooling	A	3.2 / 3.6	4.2 / 4.7	6.3 / 7.0	10.8 / 11.9				
	Heating	A	5.1 / 5.7	5.6 / 6.3	8.3 / 9.3	11.4 / 12.6				
Power Input	Cooling	W	690 (250–850)	920 (250–1,150)	1,300 (430–1,600)	2,350 (430–2,720)				
	Heating	W	1,120 (200–1,500)	1,250 (200–1,710)	1,750 (380–1,800)	2,500 (380–2,660)				
Min. Circuit Ampacity	A		15	15	15	20				
Max. Overcurrent Protection	A		15	15	20	25				
Features										
Controls			Microprocessor	Microprocessor	Microprocessor	Microprocessor				
Low Ambient Control			Equipped	Equipped	Equipped	Equipped				
Wireless Remote Controller			Included	Included	Included	Included				
Wired Remote Controller (optional)			CZ-RD516C-1	CZ-RD516C-1	CZ-RD516C-1	CZ-RD516C-1				
Fan Speeds			5 Speeds + Auto	5 Speeds + Auto	5 Speeds + Auto	5 Speeds + Auto				
Timer			24-hr Program	24-hr Program	24-hr Program	24-hr Program				
Air Deflection	Horizontal		Manual	Manual	Manual	Manual				
	Vertical		Automatic	Automatic	Automatic	Automatic				
Advanced Air Purification Features	Evaporator Guard Filter		Included	Included	Included	Included				
	PM2.5 (CZ-SA31P)		Optional	Optional	Optional	Optional				
	Anti Microbial (CZ-SA20P)		Optional	Optional	Optional	Optional				
Refrigerant			R-410A	R-410A	R-410A	R-410A				
Refrigerant control			Electric Expansion Valve	Electric Expansion Valve	Electric Expansion Valve	Electric Expansion Valve				
Operation Sound	In (Hi / Me / Lo)	dB-A	42 / 29 / 26	44 / 39 / 32	47 / 39 / 36	48 / 40 / 37				
	Outdoor (Hi)	dB-A	48	49	49	51				
Refrigerant Piping (single zone)	Type		Flare	Flare	Flare	Flare				
	Discharge	inches	1/4	1/4	1/4	1/4				
	Suction	inches	3/8	1/2	1/2	5/8				
Refrigerant Pipe Length	Outdoor Above	Ft.	Max. 65.6	Max. 65.6	Max. 100	Max. 100				
Elevation Difference*	Outdoor Above	Ft.	Max. 49.2	Max. 49.2	Max. 49.2	Max. 49.2				
	Outdoor Below	Ft.	Max. 49.2	Max. 49.2	Max. 49.2	Max. 49.2				
Dimensions & Weight										
Height	inches		11-7/16	21-9/32	11-7/16	21-9/32	11-7/16	31-5/16	11-7/16	31-5/16
Width	inches		34-9/32	30-23/32	34-9/32	30-23/32	42-5/32	34-15/32	42-5/32	34-15/32
Depth	inches		8-7/16	11-13/32	8-7/16	11-13/32	9-15/32	12-5/8	9-15/32	12-5/8
Net Weight	Lbs.		20.0	82.0	20.0	82.0	26.0	132.0	26.0	132.0

Important: You must use refrigerant piping rated for R410a.
*This is maximum elevation difference when the indoor unit is located above the outdoor unit. See p. 51 for additional information.

Pro RE Series Wall-Mounted Heat Pumps

RE9SKUA / RE12SKUA		RE18SKUA / RE24SKUA	
<p>INDOOR UNIT CS-RE9SKUA / CS-RE12SKUA</p>		<p>INDOOR UNIT CS-RE18SKUA / CS-RE24SKUA</p>	
<p>OUTDOOR UNIT CU-RE9SKUA / CU-RE12SKUA</p>		<p>OUTDOOR UNIT CU-RE18SKUA / CU-RE24SKUA</p>	

WALL MOUNT HEAT PUMPS										
Model No.	RE9SKUA		RE12SKUA		RE18SKUA		RE24SKUA			
Unit Model No.	Indoor Unit	Outdoor Unit	Indoor Unit	Outdoor Unit	Indoor Unit	Outdoor Unit	Indoor Unit	Outdoor Unit		
	CS-RE9SKUA	CU-RE9SKUA	CS-RE12SKUA	CU-RE12SKUA	CS-RE18SKUA	CU-RE18SKUA	CS-RE24SKUA	CU-RE24SKUA		
Performance & Electrical Ratings										
Capacity	Cooling	Btu/h	9,000 (4,100–10,200)	12,000 (4,100–13,300)	17,200 (5,800–18,000)	22,000 (5,800–23,000)				
	Heating	Btu/h	10,900 (4,100–14,100)	12,000 (4,100–16,300)	18,000 (5,800–20,800)	22,000 (5,800–25,400)				
Moisture Removal	High	Pints/H	1.3	2.3	2.7	6.8				
Dry Air Flow	High	CFM	425	450	670	670				
SEER	Cooling		16.0	16.0	16.0	16.0				
EER	Cooling		10.45	10.6	12.25	9.2				
HSPF	Heating		8.5	8.5	8.5	8.5				
Power Supply	V, Phase, Hz		230V / 208V, 1PH, 60Hz	230 / 208V, 1PH, 60Hz	230 / 208V, 1PH, 60Hz	230 / 208V, 1PH, 60Hz				
Running Amps	Cooling	A	4.2 / 3.8	5.5 / 5.0	7.0 / 6.3	11.7 / 10.5				
	Heating	A	4.6 / 4.2	4.5 / 4.0	6.9 / 6.2	8.8 / 7.9				
Power Input	Cooling	W	860 (250c1,000)	1,130 (250–1,300)	1,400 (430–1,550)	2,370 (430–2,550)				
	Heating	W	1,120 (200–1,500)	1,250 (200–1,710)	1,750 (380–1,800)	2,500 (380–2,660)				
Min. Circuit Ampacity	A		15	15	15	20				
Max. Overcurrent Protection	A		15	15	20	25				
Features										
Controls			Microprocessor	Microprocessor	Microprocessor	Microprocessor				
Low Ambient Control			Built-in	Built-in	Built-in	Built-in				
Wireless Remote Controller			Included	Included	Included	Included				
Wired Remote Controller (optional)			CZ-RD516C-1	CZ-RD516C-1	CZ-RD516C-1	CZ-RD516C-1				
Fan Speeds			5 Speed + Auto	5 Speed + Auto	5 Speed + Auto	5 Speed + Auto				
Timer			24-hr Program	24-hr Program	24-hr Program	24-hr Program				
Air Deflection	Horizontal		Manual	Manual	Manual	Manual				
	Vertical		Automatic	Automatic	Automatic	Automatic				
Advanced Air Purification Features	Evaporator Guard Filter		Included	Included	Included	Included				
	PM2.5 (CZ-SA31P)		Optional	Optional	Optional	Optional				
	Anti Microbial (CZ-SA20P)		Optional	Optional	Optional	Optional				
Refrigerant			R-410A	R-410A	R-410A	R-410A				
Refrigerant control			Electric Expansion Valve	Electric Expansion Valve	Electric Expansion Valve	Electric Expansion Valve				
Operation Sound	In (Hi / Me / Lo)	dB-A	43 / 35 / 32	44 / 36 / 32	48 / 39 / 36	51 / 40 / 37				
	Outdoor (Hi)	dB-A	49	52	54	55				
Refrigerant Piping	Type		Flare	Flare	Flare	Flare				
	Discharge	inches	1/4	1/4	1/4	1/4				
	Suction	inches	3/8	1/2	1/2	5/8				
Refrigerant Pipe Length	Outdoor Above	Ft.	Max. 49.2	Max. 49.2	Max. 65.6	Max. 65.6				
Elevation Difference*	Outdoor Above	Ft.	Max. 49.2	Max. 49.2	Max. 49.2	Max. 49.2				
	Outdoor Below	Ft.	Max. 49.2	Max. 49.2	Max. 49.2	Max. 49.2				
Dimensions & Weight										
Height	inches		11-7/16	21-11/32	11-7/16	21-11/32	11-7/16	27-3/8	11-7/16	27-3/8
Width	inches		34-9/32	30-23/32	34-9/32	30-23/32	42-5/32	34-15/32	42-5/32	34-15/32
Depth	inches		8-7/16	11-13/32	8-7/16	11-13/32	9-15/32	12-5/8	9-15/32	12-5/8
Net Weight	Lbs.		20.0	75.0	20.0	75.0	26.0	106.0	26.0	108.0

Important: You must use refrigerant piping rated for R410a.
*This is maximum elevation difference when the indoor unit is located above the outdoor unit. See p. 51 for additional information.

115v Wall-Mounted Heat Pumps

YE9WKU1/YE12WKU1

YE Series



INDOOR UNIT
CS-YE9WKU1 / CS-YE12WKU1



INDOOR UNIT
CU-YE9WKU1 / CU-YE12WKU1



Wireless Controller (Included)

-13°F Degrees and Base Pan Heater

WALL MOUNT HEAT PUMPS				
Indoor Unit			CS-YE9WKU1	CS-YE12WKU1
Outdoor Unit			CU-YE9WKU1	CU-YE12WKU1
Power supply			115V-/60Hz/1P	115V-/60Hz/1P
Heat Operation			-13°F	-13°F
Rated Cooling capacity		Btu/h	9000	12000
Rated Heating capacity		Btu/h	9500	12000
Cooling Capacity	95F	Btu/h	9526	12221
	47F	Btu/h	10106	12136
Heating Capacity	17F	Btu/h	5960	7018
	5F	Btu/h	7506	8294
SEER			20.0	20.0
HSPF Rating (Region IV)			10.5	10.0
EER			12.0	10.5
Moisture removal		pts/h	2.3	3.4
Base Pan Heater			Included	Included
Wireless Remote			Included	Included
Wired Remote			N/A	N/A
Power supply			115V-/60Hz/1P	115V-/60Hz/1P
Rated Current	Cooling	A	6.7	10.1
	Heating	A	7.3	10.4
Min. Circuit Ampacity			17	19
Max. Overcurrent Protection			25	30
Maximum Fuse Size		A	25	30
Indoor noise (cooling)	High/Med/Lo	dB(A)	38/35/32	40/37/34
Outdoor noise level		dB(A)	50	52
Connecting Pipe	Gas	inches	3/8"	3/8"
	Liquid	inches	1/4"	1/4"
Maximum Pipe Length		ft	50	50
Maximum height difference: indoor to outdoor		ft	16.4	16.4
Connecting Wiring	Size x Core number		4x16AWG	4x16AWG
Net dimensions (W/H/D)	Indoor	inch	31.92 x 11.49 x 8.07	31.92 x 11.49 x 8.07
	Outdoor	inch	28.66 x 21.65 x 11.22	28.66 x 21.65 x 11.22
Net weight	Indoor	lbs	17.6	17.6
	Outdoor	lbs	59.5	63.9
Packing dimensions (W/H/D)	Indoor	inch	34.84 x 14.40 x 10.94	34.84 x 14.40 x 10.94
	Outdoor	inch	33.07 x 23.82 x 13.39	33.07 x 23.82 x 13.39
Gross weight	Indoor	lbs	24.2	24.2
	Outdoor	lbs	66.1	71.6
Motor	Indoor	r/min	AC	AC
	Outdoor	r/min	DC	DC

Slim Duct Heat Pumps

E9SD3UAW / E12SD3UAW / E18SD3UAW

- Low Profile Concealed Hidden in Ceiling or Floor
- Provides Heating in Winter and Cooling in Summer
- Energy Efficient Inverter Driven Compressor

- Energy Efficient DC Fan Motor
- Air Flow Adjustment Dip Switch on Indoor Circuit Board



(E9, E12 Only)



OUTDOOR UNIT
CU-E9SD3UA
CU-E12SD3UA



OUTDOOR UNIT
CU-E18SD3UA



Wireless Controller with Receiver/Cable (Included)



Wired Controller with 32 ft cable CZ-RD52DU (Optional)

Built-In Drain Pump

Drain pump is built into the unit to raise the condensate up 20 inches from the drain pump discharge.

Pipe diameters listed below are for single zone only. For Multi-Zone, see pages 50-53 for additional information.

SLIM DUCT				
	Indoor Single or Multi		Single or Multi	Single or Multi
Series			E9SD3UA	E18SD3UA
Indoor Unit (order #)			CS-E9SD3UAW	CS-E18SD3UAW
Outdoor Unit (order #)			CU-E9SD3UA	CU-E18SD3UA
Performance Ratings				
Capacity	Cooling	Btu/h	9,000 (4,100-10,200)	11,500 (4,100-13,300)
Rated (Range)	Heating	Btu/h	12,000 (4100-14100)	13,800 (4100-16300)
Moisture Removal	High	Pints/H	1.30	4.60
Dry Air Flow	High	CFM	475	540
Static Pressure	(Standard / Switch Hi)	inch w.g.	0.10 / .022	0.10 / .023
SEER	Cooling		20.5	16.5
EER	Cooling		13.0	10.9
HSPF	Heating	Btu/h	10.0	8.5
Power Supply	V, Phase, Hz		208/230V, 1PH, 60Hz	208/230V, 1PH, 60Hz
Running Amps	Cooling	A	4.7 / 3.2	8.5 / 7.6
	Heating	A	5.7 / 5.1	9.8 / 8.7
Power Input	Cooling	W	690 (250-850)	1,58k (430-1820)
	Heating	W	1,12k (200-1500)	1,83k (380-2180)
Auxiliary Heater Connection		in. WC	Yes	Yes
Min. Circuit Ampacity		A	15	20
Max. Overcurrent Protection		A	15	25
Features				
Controls			Microprocessor	Microprocessor
Low Ambient Control			Built-in	Built-in
Wireless Controller			Included	Included
Wired Remote Controller (optional)			CZ-RD52DU	CZ-RD52DU
Indoor Fan Speeds			5 speeds	5 speeds
Air Filter			NA	NA
Duct Flange			NA	NA
Refrigerant			R-410A	R-410A
Refrigerant Control			Electric Expansion Valve	Electric Expansion Valve
Operation Sound	Indoor (Hi/Med/Lo)	dB-A	35 / 28 / 25	41 / 30 / 37
	Outdoor (Hi)	dB-A	48	49
Refrigerant Piping	Type		Flare	Flare
	Discharge	inches	1/4	1/4
	Suction	inches	3/8	1/2
Refrigerant Pipe Length		Ft.	Max. 65.6	Max. 100
Elevation Difference	Outdoor Above	Ft.	49.2	49.2
	Outdoor Below	Ft.	49.2	49.2
Dimensions & Weight				
Indoor	Height	inches	7-7/8	7-7/8
	Width	inches	29-17/32	29-17/32
	Depth	inches	25-7/32	25-7/32
	Weight	Lbs.	42.0	42.0
Outdoor	Height	inches	21-11/32	31-5/16
	Width	inches	30-23/32	34-15/32
	Depth	inches	11-13/32	12-5/8"
	Weight	Lbs.	82.0	132.0

4-Way Cassette Heat Pumps

E12RB4U / E18RB4U

INDOOR UNIT
CS-E12RB4UW*
CS-E18RB4UW*
 *Grille not included.
 Sold separately.

GRILLE ASSEMBLY
CZ-BT20U
 (Order separately)



Wireless
Controller
(Included)



Wired Controller
with 32 ft cable
CZ-RD52CU
(Optional)



OUTDOOR UNIT
CU-E12RB4U



OUTDOOR UNIT
CU-E18RB4U

Pipe diameters listed below are for single zone only. For Multi-Zone, see pages 50-53 for additional information.

4-WAY CASSETTE 24" X 24"			HEAT PUMPS			
			E12RB4U		E18RB4U	
Model No.			Indoor Unit	Outdoor Unit	Indoor Unit	Outdoor Unit
Unit Model No.			CS-E12RB4UW	CU-E12RB4U	CS-E18RB4UW	CU-E18RB4U
Grille Assembly			CZ-BT20U		CZ-BT20U	
Performance & Electrical Ratings						
Capacity	Cooling	Btu/h	11,900 (4,100-13,100)		17,500 (4,400-18,700)	
	Heating	Btu/h	13,600 (4,100-16,300)		20,400 (4,400-21,000)	
Moisture Removal	High	Pints/H	4		6.1	
	Dry Air Flow	Heating / Cooling	CFM	390 / 370		495 / 450
SEER	Cooling	Btu/Wh	18		17.5	
EER	Cooling	Btu/Wh	10.3		10.25	
HSPF	Heating	Btu/Wh	9		8.5	
Power Supply		V, Phase, Hz	208/230V, Single phase, 60Hz		208/230V, Single phase, 60Hz	
Running Amps	Cooling	A	6 (1.25-6.3)		9.1 (1.2-8.3)	
	Heating	A	6.9 (1.25-7.3)		12.5 (1.3-10.5)	
Power Input	Cooling	W	1,150 (250-1,320)		1,700 (250-1,850)	
	Heating	W	1,360 (230-1,710)		2,340 (270-2,500)	
Min. Circuit Ampacity		A	15		20	
Max. Overcurrent Protection		A	15		25	
Features						
Controls			Microprocessor		Microprocessor	
Low Ambient Control (for Cooling)			Equipped		Equipped	
Wireless Remote Controller			Included		Included	
Wired Remote Controller (optional)			CZ-RD52CU		CZ-RD52CU	
Fan Speeds			Hi/Me/Lo & Auto		Hi/Me/Lo & Auto	
Air Deflection	Horizontal		—		—	
	Vertical		Microprocessor		Automatic	
Air Filter			Washable		Washable	
Refrigerant			R-410A		R-410A	
Refrigerant Control			Electric Expansion Valve		Electric Expansion Valve	
Operation Sound	In (Hi / Me / Lo)	dB-A	34 / 30 / 27		44 / 31 / 28	
	Outdoor (Hi)	dB-A	51 (Max. 66)		52 (Max. 66)	
Refrigerant Piping (single zone)	Type		Flare		Flare	
	Discharge	inches	1/4		1/4	
	Suction	inches	1/2		1/2	
Refrigerant Pipe Length		Ft.	65		100	
Elevation Difference*	Outdoor Above	Ft.	49		49	
	Outdoor Below	Ft.	49		49	
Dimensions & Weight			Indoor Unit	Outdoor Unit	Indoor Unit	Outdoor Unit
Height	inches		10-1/4	21-1/2	10-1/4	31-1/2
Width	inches		22-3/4	31	22-3/4	34-1/2
Depth	inches		22-3/4	11-1/2	22-3/4	12-3/4
Net Weight	Lbs.		40	82	40	132

4-Way Airflow Design Sends Cool Air in All Directions

Air is returned through the center of the grille, while evenly distributing air through each of the 4 supply air openings. Installation in the center of the room provides for the greatest comfort. However, 1 or 2 supply louvers can be closed for installation near 1 wall to provide 3 or 2 way airflow. Also, by closing off 1 supply louver.

Comfort/Quiet



Integrated Drain Pump

Drain pump is built into the unit to raise the condensate water up to 20" from the drain pump discharge to a gravity drain.

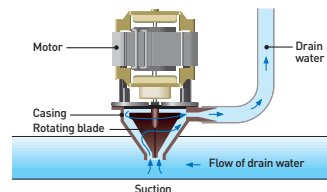

Multi-Zone Systems

Outdoor Units

See following pages for outdoor models specifications and combinations.



2 Zone (1.5 Ton)
CU-2E18SBU-5



Cooling Capacity: 16,700 (7,200 - 20,000) Btu/hr.
 Heating Capacity: 20,200 (7,200 - 24,600) Btu/hr.
 SEER Non-Ducted 18.0 / Ducted 18.0
 EER Non-Ducted 12.55 / Ducted 12.55
 HSPF Non-Ducted 8.8 / Ducted 8.8
 Min/Max capacity 11,000 - 21,800 Btu/hr.



2-3 Zone (1.5 Ton)
CU-3E19RBU-5



(Non-Ducted)

Cooling Capacity: 19,000 (6,100 - 24,800) Btu/hr.
 Heating Capacity: 26,000 (5,500 - 28,400) Btu/hr.
 SEER Non-Ducted 22.0 / Ducted 18.5
 EER Non-Ducted 12.55 / Ducted 10.85
 HSPF Non-Ducted 10.5 / Ducted 9.0
 Min/Max capacity 15,300 - 30,600 Btu/hr.



2-4 Zones (2 Ton)
CU-4E24RBU-5



(Non-Ducted)

Cooling Capacity: 24,000 (10,200 - 31,400) Btu/hr.
 Heating Capacity: 37,800 (14,300 - 48,500) Btu/hr.
 SEER Non-Ducted 22.0 / Ducted 19.0
 EER Non-Ducted 12.55 / Ducted 10.85
 HSPF Non-Ducted 9.5 / Ducted 9.0
 Min/Max capacity 15,300 - 30,600 Btu/hr.



2-5 Zones (3 Ton)
CU-5E36QBU-5



Cooling Capacity: 36,000 (9,900 - 39,000) Btu/hr.
 Heating Capacity: 37,800 (11,600 - 49,500) Btu/hr.
 SEER Non-Ducted 18.5 / Ducted 16.5
 EER Non-Ducted 9.6 / Ducted 8.3
 HSPF Non-Ducted 10.0 / Ducted 9.5
 Min/Max capacity 15,300 - 59,500 Btu/hr.

All multi split condensers must have minimum of two indoor units installed.

Advantages of Multi-Zone Inverter System





- Year-round comfort with Multi-Zone Heating & Cooling.
- Combine low-energy Inverter Technology and Ductless Zone Control for optimum energy efficiency.
- Cool and Heat 2-5 rooms or a whole house with one outdoor condenser and up to 5 ductless indoor units.
- Eliminate cost of duct installation and cleaning.

nanoe™X ClimaPure™ Compatibility (CU-3E19RBU-5)

- Built-in air and surface purification technology that provides a comfortable environment for occupants by reducing pollutants and odours.



Combination Possibilities

MULTI-ZONE		CU-2E18SBU-5	CU-3E19RBU-5	CU-4E24RBU-5	CU-5E36QBU-5
Wall	CS-ME5RKUA	✓	✓	✓	✓
	CS-ME7RKUA	✓	✓	✓	✓
	CS-E9RKUAW	✓	✓	✓	✓
	CS-E12RKUAW	✓	✓	✓	✓
	CS-E18RKUAW	—	✓	✓	✓
	CS-E24RKUAW	—	—	✓	✓
	CS-XE9WKUAW - NEW 	—	✓	—	—
	CS-XE12WKUAW - NEW 	—	✓	—	—
	CS-XE15WKUAW - NEW 	—	✓	—	—
	CS-XE18WKUAW - NEW 	—	✓	—	—
CS-XE24WKUAW - NEW 	—	—	—	—	
4-Way	CS-ME9SB4U	✓	✓	✓	✓
	CS-E12RB4UW	✓	✓	✓	✓
	CS-E18RB4UW	—	✓	✓	✓
Ducted	CS-ME5SD3UA	✓	✓	✓	✓
	CS-ME7SD3UA	✓	✓	✓	✓
	CS-E9SD3UAW	✓	✓	✓	✓
	CS-E12SD3UAW	✓	✓	✓	✓
	CS-E18SD3UAW	—	✓	✓	✓
Capacity range of connectable indoor units		3.2 – 6.4 kW	4.5 – 9.0 kW	4.5 – 13.6 kW	4.5 – 17.5 kW
Piping Length	1 room maximum pipe length (m (ft))	25 (82.0)	25 (82.0)	25 (82.0)	25 (82.0)
	Allowable elevation (m (ft))	15 (49.2)	15 (49.2)	15 (49.2)	15 (49.2)
	Total allowable pipe length (m (ft))	50 (164.0)	50 (164.0)	70 (229.6)	80 (262.4)
	Total pipe length for maximum chargeless length (m (ft))	20 (65.6)	30 (98.4)	45 (147.6)	45 (147.6)
	Additional gas amount over chargeless length (g/m (oz/ft))	20 (0.2)	20 (0.2)	20 (0.2)	20 (0.2)

Multi-Zone Systems

Indoor Units

Wall Mount



CS-ME5RKUA / CS-ME7RKUA / CS-E9RKUAW / CS-E12RKUAW / CS-E18RKUAW
CS-XE9WKUAW / CS-XE12WKUAW / CS-XE15WKUAW / CS-XE18WKUAW 



4-Way Cassette



CS-ME9SB4U / CS-E12RB4UW / CS-E18RB4UW



Slim Duct



CS-ME5SD3UA / CS-ME7SD3UA / CS-E9SD3UAW / CS-E12SD3UAW / CS-E18SD3UAW



All Indoor Multi-Zone units can be field modified to operate as Cooling Only.

Multi-Zone Systems

WALL MOUNT								
Model No.			CS-ME5RKUA	CS-ME7RKUA	CS-E9RKUAW	CS-E12RKUAW	CS-E18RKUAW	CS-E24RKUAW
Performance & Electrical Ratings								
Capacity	Cooling	Btu/h	5,500 (4,400-7,800)	6,900 (6,100-9,900)	8,600 (6,100-9,900)	10,900 (6,100-13,000)	17,100 (6,500-19,800)	24,000 (5,800-27,200)
	Heating	Btu/h	8,900 (4,100-10,900)	10,900 (4,100-14,000)	12,300 (4,100-14,700)	15,300 (4,100-19,800)	23,400 (19,400-4,100)	28,800 (5,800-29,200)
Moisture Removal	High	Pints/H	0.6	0.8	1.1	1.3	3.0	7.6
Dry Air Flow	High	CFM	415	425	430	475	680	715
Power Supply	V, Phase, Hz		208/230V, 1PH, 60Hz	230/208V, 1PH, 60Hz	230/208V, 1PH, 60Hz	230/208V, 1PH, 60Hz	230/208V, 1PH, 60Hz	230/208V, 1PH, 60Hz
Running Amps	Cooling	A	2.0 / 2.3	2.5 / 2.8	3.2 / 3.5	3.9 / 4.3	7.2 / 8.0	10.8 / 11.9
	Heating	A	3.0 / 3.4	3.7 / 4.1	4.7 / 5.2	6.0 / 6.6	8.3 / 9.3	11.4 / 12.6
Power Input	Cooling	W	400 (250-640)	500 (340-810)	630 (340-810)	800 (340-1,360)	1,300 (430-1,600)	2,350 (430-2,720)
	Heating	W	600 (300-960)	740 (300-1,230)	940 (300-1,230)	1,230 (200-2,100)	1,750 (380-1,800)	2,500 (380-2,660)
Operation Sound [Hi / Me / Lo / Q-Lo]	Cooling		38 / 25	39 / 25	40 / 25	43 / 28	47 / 39 / 36	48 / 40 / 37
	Heating		40 / 29	41 / 29	42 / 29	44 / 35 / 32	46 / 39 / 36	48 / 40 / 37
Refrigerant Tube Diameter	Discharge	inches	1/4"	1/4"	1/4"	1/4"	1/4"	1/4"
	Suction	inches	3/8"	3/8"	3/8"	3/8"	3/8"	1/2"
Adapters Required			none	none	none	CZ-MA1P-US	CZ-MA1P-US	CZ-MA2P-US and CZ-MA3P-US
Dimensions & Weight								
Height	inches		11-7/16"	11-7/16"	11-7/16"	11-7/16"	11-7/16"	11-7/16"
Width	inches		34-9/32"	34-9/32"	34-9/32"	34-9/32"	42-5/32"	42-5/32"
Depth	inches		8-7/16"	8-7/16"	8-7/16"	8-7/16"	9-15/32"	9-15/32"
Net Weight	lb		20.0	20.0	20.0	20.0	26.0	26.0

CLIMAPURE WALL MOUNT						
Model No.			CS-XE9WKUAW	CS-XE12WKUAW	CS-XE15WKUAW	CS-XE18WKUAW
Performance & Electrical Ratings						
Capacity	Cooling	Btu/h	8,700 (2,800-12,000)	11,500 (2,800-14,000)	14,700 (2,800-14,000)	17,200 (3,300-19,800)
	Heating	Btu/h	10,900 (3,000-18,000)	12,000 (3,000-23,000)	17,200 (3,300-24,000)	20,400 (5,800-30,000)
Moisture Removal	High	Pints/H	1.3	2.5	4	3.6
Dry Air Flow	High	CFM	380	415	430	560
Power Supply	V, Phase, Hz		208-230/1/60	208-230/1/60	208-230/1/60	208-230/1/60
Running Amps	Cooling	A	2.6/2.9	3.8/4.2	5.4/6.0	6.2/6.9
	Heating	A	3.2/3.6	3.8/4.2	5.8/6.6	7.7/8.7
Power Input	Cooling	W	540	810	1170	1300
	Heating	W	670	800	1260	1630
Operation Sound [Hi / Me / Lo / Q-Lo]	Cooling		42 / 25 / 20	45 / 28 / 20	45 / 37 / 34	47 / 39 / 36
	Heating		42 / 29 / 26	44 / 35 / 32	47 / 37 / 34	48 / 39 / 36
Refrigerant Tube Diameter	Discharge	inches	1/4"	1/4"	1/4"	1/4"
	Suction	inches	3/8"	1/2"	1/2"	1/2"
Dimensions & Weight						
Height	inches		11-5/8"	11-5/8"	11-5/8"	11-29/32"
Width	inches		34-9/32"	34-9/32"	34-9/32"	43-13/32"
Depth	inches		9-1/16"	9-1/16"	9-1/16"	9-5/8"
Net Weight	lb		24	24	24	33

Multi-Zone Systems

4-WAY CASSETTE					
Model No.			CS-ME9SB4U	CS-E12RB4UW	CS-E18RB4UW
Performance & Electrical Ratings					
Capacity	Cooling	Btu/h	8,600 (6,100 - 9,900)	10,900 (6,100-13,000)	171,000 (6,500-19,400)
	Heating	Btu/h	12,300 (4,100 - 14,700)	15,300 (4,100-19,800)	23,400 (4,100-23,600)
Moisture Removal	High	Pints/H	2.5	3.2	4.4
Dry Air Flow	High	CFM	400	370(C),390(H)	450(C),495(H)
Power Supply	V, Phase, Hz		208/230V, 1PH, 60Hz	230/208V, 1PH, 60Hz	230/208V, 1PH, 60Hz
Running Amps	Cooling	A	3.5 / 3.2	4.3 / 3.9	8.0 / 7.2
	Heating	A	5.2 / 4.7	6.6 / 6.0	10.7 / 9.7
Power Input	Cooling	W	630 (340 - 810)	800 (340-1,360)	1,550 (340-2,130)
	Heating	W	300 (940 - 1.2k)	1,230 (300-2,100)	2,100 (300-2,520)
Operation Sound [Hi / Me / Lo / Q-Lo]	Cooling		36 / 30 / 27	36 / 30	36 / 32
	Heating		37 / 32 / 29	36 / 32	46 / 33
Refrigerant Tube Diameter	Discharge	inches	1/4	1/4	1/4
	Suction	inches	3/8"	3/8	3/8
Adapters Required			none	CZ-MA1P-US	CZ-MA1P-US
Dimensions & Weight					
Indoor	Height	inches	10-1/4"	10-1/4	10-1/4
	Width	inches	22-3/4"	22-3/4	22-3/4
	Depth	inches	22-3/4"	22-3/4	22-3/4
	Net Weight	lb	40.0 (grille 6.0)	40.0	40.0

Pipe diameters listed below are for Multi-Zone installations. For Single zone pipe diameter see single zone product pages.

SLIM DUCT							
Model No.			CS-ME5SD3UA	CS-ME7SD3UA	CS-E9SD3UAW	CS-E12SD3UAW	CS-E18SD3UAW
Performance & Electrical Ratings							
Capacity	Cooling	Btu/h	5,500 (4,400 - 7,800)	6,900 (6,100 - 9,900)	9000 (4100-10200)	11500 (4100-13300)	17200 (5800-19400)
	Heating	Btu/h	8,900 (4,100 - 10,900)	10,900 (4,100 - 14,000)	12000 (4100-14100)	13800 (4100-16300)	20800 (5800-24200)
Moisture Removal	High	Pints/H	0.8	1.1	1.30	1.70	4.60
Dry Air Flow	High	CFM	484	494	475	475	540
Static Pressure	(Standard / Switch Hi) w.g.	inch	0.10 / .022	0.10 / .022	0.10 / .022	0.10 / .022	0.10 / .023
Power Supply	V, Phase, Hz		208/230V, 1PH, 60Hz	208/230V, 1PH, 60Hz	208/230V, 1PH, 60Hz	208/230V, 1PH, 60Hz	208/230V, 1PH, 60Hz
Running Amps	Cooling	A	2.3 / 2.0	2.8 / 2.5	3.2	4.2	7.6
	Heating	A	3.4 / 3.0	4.1 / 3.7	5.1	5.6	8.7
Power Input	Cooling	W	400 (250 - 640)	500 (340 - 810)	690 (250 - 850)	920 (250 - 1.15k)	1.58k (430 - 1.82k)
	Heating	W	600 (300 - 960)	740 (300 - 1.23k)	1.12k (200 - 1.50k)	1.25k (200 - 1.71k)	1.83k (380 - 2.18k)
Operation Sound [Hi / Me / Lo / Q-Lo]	Cooling		35 / 28	36 / 29	35 / 28 / 25	35 / 28 / 25	41 / 30 / 37
	Heating		35 / 28	36 / 29	35 / 28 / 25	35 / 28 / 25	41 / 32 / 29
Refrigerant Tube Diameter	Discharge	inches	1/4"	1/4"	1/4	1/4	1/4
	Suction	inches	3/8"	3/8"	3/8	3/8	3/8
Adapters Required			none	none	none	CZ-MA1P-US	CZ-MA1P-US
Dimensions & Weight							
Indoor	Height	inches	7-7/8"	7-7/8"	7-7/8	7-7/8	7-7/8
	Width	inches	29-17/32"	29-17/32"	29-17/32	29-17/32	29-17/32
	Depth	inches	25-7/32"	25-7/32"	25-7/32	25-7/32	25-7/32
	Net Weight	lb	42.0	42.0	42.0	42.0	42.0

Important: You must use refrigerant piping rated for R410a.

*This is maximum elevation difference when the indoor unit is located above the outdoor unit. See pages 50-53 for additional information.

Multi-Zone Systems

-5°F Heat Operation

2 Zone (1.5 Ton)

CU-2E18SBU-5

Cooling Capacity: 16,700 (7,200 - 20,000) Btu/hr.
 Heating Capacity: 20,200 (7,200 - 24,600) Btu/hr.
 SEER Non-Ducted 19.0 / Ducted 19.0
 EER Non-Ducted 12.55 / Ducted 12.55
 HSPF Non-Ducted 9.5 / Ducted 9.0
 Min/Max capacity 11,000 - 21,800 Btu/hr.

Connect 2 Indoor Units



CU-2E18SBU-5



See Multi-Zone Calculation and Selection Chart on pp. 42-43.

-5°F Heat Operation

2-3 Zone (1.5 Ton)

CU-3E19RBU-5

Cooling Capacity: 19,000 (6,100 - 24,800) Btu/hr
 Heating Capacity: 26,000 (5,000 - 28,400) Btu/hr
 SEER Non-Ducted 22.0 / Ducted 18.5
 EER Non-Ducted 12.55 / Ducted 10.85
 HSPF Non-Ducted 10.5 / Ducted 9.0
 Min/Max capacity 15,300 - 30,600 Btu/hr



CU-3E19RBU-5

All multi-split condensers must have minimum two indoor units installed.

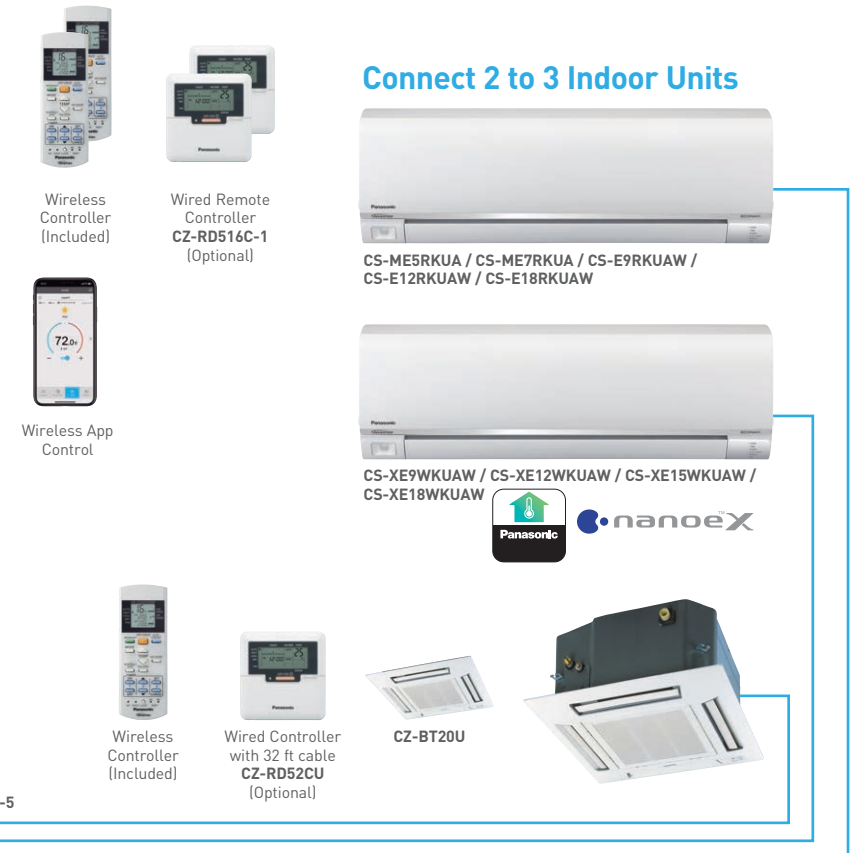

Outdoor Unit

MODEL NO.	CU-2E18SBU-5	
Performance	Cooling	Heating
Capacity	16,700 (7,200-20,000) Btu/h	20,200 (7,200-24,600)
Air Circulation	High	1,447 CFM
Number of Connectable Indoor Units	2	
SEER	Non-Ducted / Ducted	19.0 / 19.0
EER	Non-Ducted / Ducted	12.55 / 12.55
HSPF	Non-Ducted / Ducted	9.5 / 9.0
Electrical Rating	230V / 208V, 1PH, 60Hz	
Power Supply	V, Phase, Hz	
Running Ampere	Non-Ducted / Ducted	A
Power Input	W	
Maximum Fuse Size : MCA / MOCP	Amps	
Features	Microprocessor	
Controls	Variable Speed	
Fan Speeds	DC Inverter	
Compressor	R-410A / 78.70 oz	
Refrigerant / Amount Charged at Shipment	Electronic Expansion Valve	
Refrigerant Control	48 dB-A	
Operation Sound	Hi	49
Refrigerant Tubing Connections	Type	
Max. Allowable Tubing Length	Ft.	
Refrigerant Tube Diameter (service value)	Discharge	inch
	Suction	inch
Adapter Required	Indoor 12K Btu/hr. requires 1 CZ-MA1P-US	
Dimensions & Weight	31-5/16" x 34-15/32" (+3-3/4) x 14-3/6"	
Unit Dimensions	H x W x D	inch
Net Weight	Lbs.	

Important: You must use refrigerant piping rated for R410a. See pages 50-53 for additional information.
 *Test Conditions based on AHRI 210/240

Outdoor Unit

MODEL NO.	CU-3E19RBU-5	
Performance	Cooling	Heating
Capacity	19,000 (6,100-24,800) Btu/h	26,000 (5,500-28,400)
Air Circulation	High	1,447 CFM
Number of Connectable Indoor Units	2-3	
SEER	Non-Ducted / Ducted	22.0 / 18.5
EER	Non-Ducted / Ducted	12.55 / 10.85
HSPF	Non-Ducted / Ducted	10.5 / 9.0
Electrical Rating	230V / 208V, 1PH, 60Hz	
Power Supply	V, Phase, Hz	
Running Ampere	Non-Ducted / Ducted	A
Power Input	W	
Maximum Fuse Size : MCA / MOCP	Amps	
Features	Microprocessor	
Controls	Variable Speed	
Fan Speeds	Twin Rotary, DC Motor, Inverter	
Compressor	R-410A / 93.2 oz	
Refrigerant / Amount Charged at Shipment	Electronic Expansion Valve	
Refrigerant Control	50 dB-A	
Operation Sound	Hi	52
Refrigerant Tubing Connections	Type	
Max. Allowable Tubing Length	Ft.	
Refrigerant Tube Diameter (service value)	Discharge	inch
	Suction	inch
Adapter Required	Indoor 12 and 18 Btu/hr. require 1 CZ-MA1P-US	
Dimensions & Weight	31-5/16 x 34-15/32 x 14-3/6"	
Unit Dimensions	H x W x D	inch
Net Weight	Lbs.	

Important: You must use refrigerant piping rated for R410a.

Multi-Zone Systems

-5°F Heat Operation

2-4 Zone (2 Ton)

A minimum of 2 indoor units must be connected.

CU-4E24RBU-5

Cooling Capacity: 24,000 (10,200 - 31,400) Btu/hr.
 Heating Capacity: 37,800 (14,300 - 48,500) Btu/hr.
 SEER Non-Ducted 22.0 / Ducted 19.0
 EER Non-Ducted 12.55 / Ducted 10.85
 HSPF Non-Ducted 9.5 / Ducted 9.0
 Min/Max capacity 15,300 - 30,600 Btu/hr.

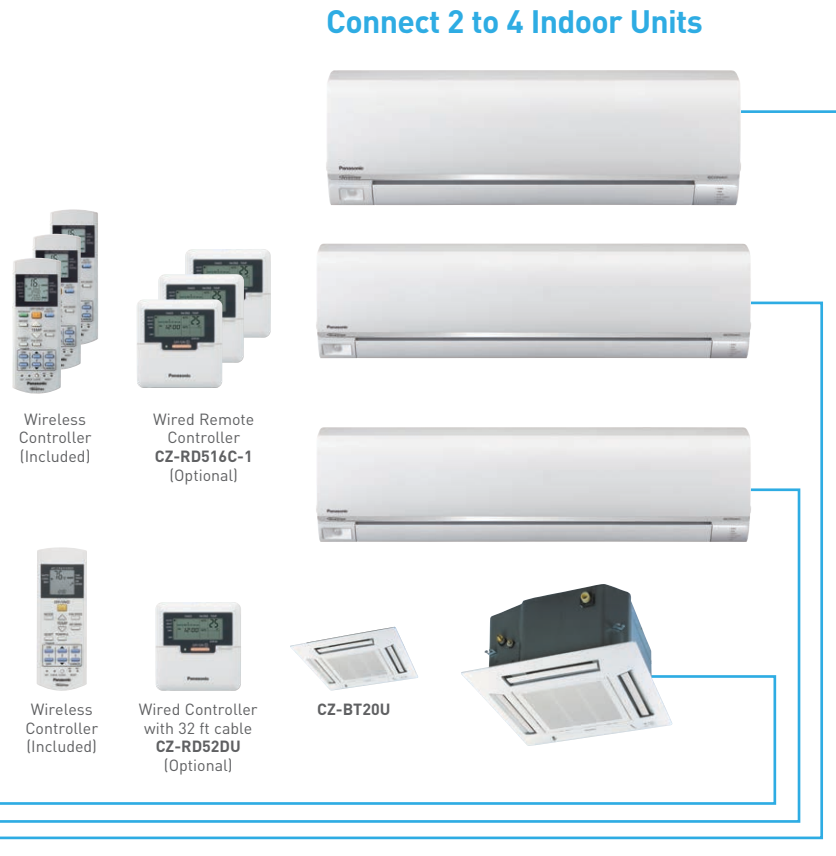

CU-4E24RBU-5 (Non-Ducted)

See Multi-Zone Calculation and Selection Chart on pp. 42-43.

Outdoor Unit

MODEL NO.	CU-4E24RBU-5	
Performance	Cooling	Heating
Capacity	Btu/h 24,000 (10,200-31,400)	Btu/h 37,800 (14,300-48,500)
Air Circulation	High CFM 1,963	High CFM 2,330
Number of Connectable Indoor Units	2-4	
SEER	Non-Ducted / Ducted 22.0 / 19.0	
EER	Non-Ducted / Ducted 12.55 / 10.85	
HSPF	Non-Ducted / Ducted 9.5 / 9.0	
Electrical Rating	230V / 208V, 1PH, 60Hz	
Power Supply	V, Phase, Hz	
Running Ampere	Non-Ducted / Ducted A 9.9-8.9 / 11.4-10.3	15.3-13.9 / 17.8-16.1
Power Input	W 1,910 (530-2,870)	3,030 (700-4,380)
Maximum Fuse Size : MCA / MOCP	Amps 30/45	
Features	Microprocessor Variable Speed	
Controls	Fan Speeds	
Compressor	Twin Rotary, DC Motor, Inverter	
Refrigerant / Amount Charged at Shipment	R-410A / 120.0 oz	
Refrigerant Control	Electronic Expansion Valve	
Operation Sound	Hi dB-A 55	55
Refrigerant Tubing Connections	Type Flare	
Max. Allowable Tubing Length	Ft. 230 per system (82 per indoor unit)	
Refrigerant Tube Diameter (service value)	Discharge inch 1/4" x 4	Suction inch 3/8" x 4
Adapter Required	Indoor 12 and 18 Btu/hr. require 1 CZ-MA1P-US / 24 Btu/hr 1 CZ-MA1P-US and 1 CZ-MA3P-US**	
Dimensions & Weight	39-11/32 x 37-1/32 x 13-13/32	
Unit Dimensions	H x W x D inch	
Net Weight	Lbs.	183

Important: You must use refrigerant piping rated for R410a. See pages 50-53 for additional information.
 **Test Conditions based on AHRI 210/240

-5°F Heat Operation

2-5 Zone (3 Ton)

A minimum of 2 indoor units must be connected.

CU-5E36QBU-5

Cooling Capacity: 36,000 (9,900 - 39,000) Btu/hr.
 Heating Capacity: 37,800 (11,600 - 49,500) Btu/hr.
 SEER Non-Ducted 18.5 / Ducted 16.5
 EER Non-Ducted 9.6 / Ducted 8.3
 HSPF Non-Ducted 10.0 / Ducted 9.5
 Min/Max capacity 15,300 - 59,500 Btu/hr.



CU-5E36QBU-5 (Non-Ducted)

See Multi-Zone Calculation and Selection Chart on pp. 42-43.

Outdoor Unit

MODEL NO.	CU-5E36QBU-5	
Performance	Cooling	Heating
Capacity	Btu/h 36,000 (9,900-39,000)	Btu/h 37,800 (11,600-49,500)
Air Circulation	High CFM 2,475	High CFM 2,900
Number of Connectable Indoor Units	2-5	
SEER	Non-Ducted / Ducted 18.5 / 16.5	
EER	Non-Ducted / Ducted 9.6 / 8.3	
HSPF	Non-Ducted / Ducted 10.0 / 9.5	
Electrical Rating	230V / 208V, 1PH, 60Hz	
Power Supply	V, Phase, Hz	
Running Ampere	Non-Ducted / Ducted A 19.0-17.2 / 21.1-19.1	14.8-13.4 / 17.5-15.8
Power Input	W 3,750 (550-3,860)	2,900 (530-4,240)
Maximum Fuse Size : MCA / MOCP	Amps 30/45	
Features	Microprocessor Variable Speed	
Controls	Fan Speeds	
Compressor	Twin Rotary, DC Motor, Inverter	
Refrigerant / Amount Charged at Shipment	R-410A / 120.0 oz	
Refrigerant Control	Electronic Expansion Valve	
Operation Sound	Hi dB-A 55	55
Refrigerant Tubing Connections	Type Flare	
Max. Allowable Tubing Length	Ft. 262 per system (82 per indoor unit)	
Refrigerant Tube Diameter (service value)	Discharge inch 1/4" x 5	Suction inch 3/8" x 5
Adapter Required	CZ-MA2P 1 pc for 12K & 18K / CZ-MA2P	
Indoor Adapter	Indoor 12 and 18 Btu/hr. require 1 CZ-MA2P-US / 24 Btu/hr. 1 CZ-MA1P-US and 1 CZ-MA3P-US	
Dimensions & Weight	39-11/32 x 37-1/32 x 13-13/32	
Unit Dimensions	H x W x D inch	
Net Weight	Lbs.	183

Important: You must use refrigerant piping rated for R410a. See pages 50-53 for additional information.
 **Test Conditions based on AHRI 210/240

Remote Controllers – Residential (RAC)

SERIES	WIRELESS	WIRED
 <p>ClimaPure™ XE</p> <p>CS-XE9WKUAW CS-XE12WKUAW CS-XE15WKUAW CS-XE18WKUAW CS-XE24WKUAW</p>	 <p>(Included)</p>	
 <p>Exterios E</p> <p>CS-ME5RKUA CS-ME7RKUA CS-E9RKUAW CS-E12RKUAW CS-E18RKUAW CS-E24RKUAW</p>	 <p>(Included)</p>	 <p>CZ-RD516C-1 (Optional)</p>
 <p>Pro Series</p> <p>CS-RE9SKUA CS-RE12SKUA CS-RE18SKUA CS-RE24SKUA</p>	 <p>(Included)</p>	
 <p>Pro Series (115v)</p> <p>CS-YE9WKU1 CS-YE12WKU1</p>	 <p>(Included)</p>	N/A
 <p>Slim Duct</p> <p>CS-ME5SD3UA CS-ME7SD3UA CS-E9SD3UAW CS-E12SD3UAW CS-E18SD3UAW</p>	 <p>(Included)</p>	 <p>CZ-RD52DU (Option)</p>
 <p>4-Way Cassette</p> <p>CS-ME9SB4U CS-E12RB4UW CS-E18RB4UW</p>	 <p>(Included)</p>	 <p>CZ-RD52CU (Option)</p>

Panasonic Built-in Wi-Fi and App

A new built-in Network Adapter that allows you to control your heat pump from everywhere.

Available with ClimaPure™ XE Series
 – CS-XE9WKUAW – CS-XE18WKUAW
 – CS-XE12WKUAW – CS-XE24WKUAW
 – CS-XE15WKUAW

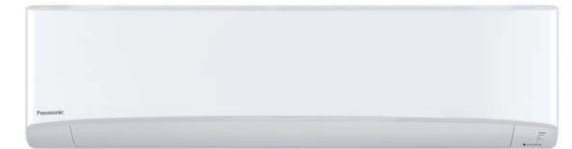

- Requires the APP to work with a smartphone with Android 4.4 and above, or iOS 9 and above. However, it can't be guaranteed that the APP will work well with all Android OS version.
- The Network Adapter is designed specifically as a terminal for Panasonic Control app.
- The Wireless LAN network coverage must reach the air conditioner installation location.



Specification

Network Adapter	Wireless LAN Module (built-in)
Model	DNSK-P11
Input Voltage	DC 5V (From Air Conditioner Indoor Unit)
Current Consumption	Tx/Rx max. 290/100 mA
Wireless LAN standard	IEEE 802.11 b/g/n
Frequency range	2.4 GHz band
Encryption	WPA2-PSK (TKIP/AES)

Maximum radio-frequency power transmitted in the frequency bands



Type of wireless	Frequency band	Max. EIRP (dBm)
WLAN	12 - 2472 MHz	20 dBm

App Instructions

For Android user (Android 4.4 and above)	For iOS user (iOS 9 and above)
<ul style="list-style-type: none"> • Open  • Search for "Panasonic Comfort." • Download and install. 	<ul style="list-style-type: none"> • Open  • Search for Panasonic Control app. • Download and install.

Wi-Fi Adapter*

Internet Connect devices remotely control a system with one or more indoor units via the cloud. An Internet Control adapter is required for every indoor unit. Requires an internet connection and a Wi-Fi router, Control your equipment using any web browser, iOS or Android device.

 <p>USPA-AC-WIFI-1B</p>	<p>RAC Residential Wired Wi-Fi Adapter For compatible units, this Internet Control device is mounted next to the indoor unit and connects to the main board with the supplied cable. It can be used with wired and wireless remotes.</p>			
 <p>USIS-IR-WIFI-1</p>	<p>RAC & PAC Residential and Light Commercial Wireless Adapter This universal Internet Control infrared (IR) hub can control any RAC or PAC indoor unit with the factory wireless remote or optional wireless kit. It can be used on a table top or wall mount to send IR signals to the unit.</p>			
<p>All Internet Control features are included for free up to 50 indoor units. The Pro License is required to control 51 or more indoor units.</p> <table border="0"> <tr> <td> <ul style="list-style-type: none"> • On/Off • Heat, Cool, Dry and Auto Modes • Set Point Temperature • Adjust Fan Speed • Louver Direction (if applicable) • Ambient Temperature </td> <td> <ul style="list-style-type: none"> • AC Unit Error Signals, Codes and Descriptions • Multi-lingual Interface • Automatic Firmware Updates • Allows Multiple Users • Annual Schedule Up to 10 Timers and Scenes • Multiple Home/Zone Management </td> <td> <ul style="list-style-type: none"> • Multiple Home/Zone Management • Powerful and Energy Savings Models • Advanced User Functions • AC Unit Error Signals, Codes and Descriptions • Error E-mail Notifications • User Defined Alerts </td> </tr> </table>		<ul style="list-style-type: none"> • On/Off • Heat, Cool, Dry and Auto Modes • Set Point Temperature • Adjust Fan Speed • Louver Direction (if applicable) • Ambient Temperature 	<ul style="list-style-type: none"> • AC Unit Error Signals, Codes and Descriptions • Multi-lingual Interface • Automatic Firmware Updates • Allows Multiple Users • Annual Schedule Up to 10 Timers and Scenes • Multiple Home/Zone Management 	<ul style="list-style-type: none"> • Multiple Home/Zone Management • Powerful and Energy Savings Models • Advanced User Functions • AC Unit Error Signals, Codes and Descriptions • Error E-mail Notifications • User Defined Alerts
<ul style="list-style-type: none"> • On/Off • Heat, Cool, Dry and Auto Modes • Set Point Temperature • Adjust Fan Speed • Louver Direction (if applicable) • Ambient Temperature 	<ul style="list-style-type: none"> • AC Unit Error Signals, Codes and Descriptions • Multi-lingual Interface • Automatic Firmware Updates • Allows Multiple Users • Annual Schedule Up to 10 Timers and Scenes • Multiple Home/Zone Management 	<ul style="list-style-type: none"> • Multiple Home/Zone Management • Powerful and Energy Savings Models • Advanced User Functions • AC Unit Error Signals, Codes and Descriptions • Error E-mail Notifications • User Defined Alerts 		

Note: Not all features are available on all indoor models

Wireless Home App – Internet Connect

Control your home's comfort with the smart Internet Control device via smartphones, tablet and PC and via the internet.

Offering the same functions as if you were at home or office: start/stop, mode operation, set temperature, room temperature etc. As well as the new, advanced functionality provided by internet control to achieve the best comfort and efficiency with the lowest energy consumption.

What's Internet Control?

Internet Control is a next generation system providing a user-friendly remote control of air conditioning or heat pump units from everywhere, using a simple Android or iOS smartphone, tablet or PC via web browser.

Simple Installation

Just connect the Internet Control device to the air conditioner or heat pump with the supplied wire and then link it to your Wi-Fi access point.

Internet Control. Easy to install. Maximum benefit

Internet Control is underlined with the slogan "Your Home in the Cloud," meaning a simple and easy to handle solution has been considered for every user to manage the device, not requiring any communication or computer skills.

No servers. No adapters. No wires. Just a small box is needed to be connected and placed close to the air conditioning indoor unit and your smartphone, tablet or PC.

Your existing Wi-Fi connection does the rest when you are at home. Start the App from your smartphone device, your tablet or your computer, and enjoy a new experience in comfort. And if you are out of town, just launch the App, and manage the air conditioning of your home from the cloud.

An intuitive and user-friendly interface that lets you manage your air conditioning unit in the same way you do with the remote controller at home.

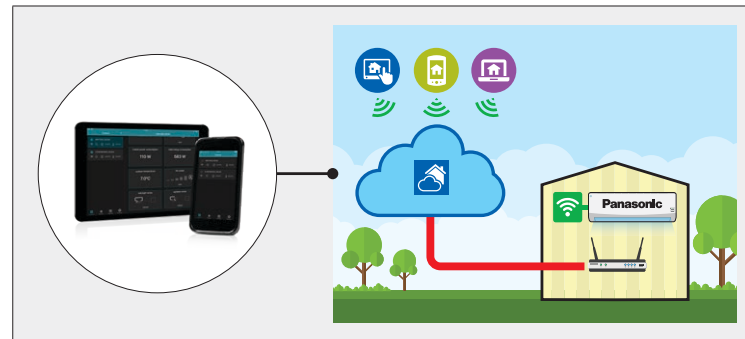

Internet control can be downloaded in from the **AppStore** or **PlayStore**.

* Use optional external Wi-Fi Adapter and App for Internet connection with all models. See Interface Controls list.



BACnet Integration

BACnet IP and MSTP Controller. Requires (1) device per indoor unit.

 <p>USPA-AC-BAC-1</p>	<p>RAC Residential BACnet Controller This is a BACnet over IP or MSTP device. Configured using external dip switches. Includes an HTML based interface that can be used for additional control and BACnet network settings.</p>
 <p>USPA-RC2-BAC-1</p>	<p>PAC Residential & Light Commercial BACnet Controller This is a BACnet over IP or MSTP device capable of monitoring and controlling all generations of PACi, ECOi and ECOi EX units. Configured using external dip switches. Includes an HTML based interface that can be used for additional control and BACnet network settings.</p>
<p>The USPA-AC-BAC-1, USPA-RC2-BAC-1 all feature occupied/unoccupied heat and cool set points for reduced programming time and greater energy efficiency.</p>	
<p>Global and Individual Operation/Setting Objects</p> <ul style="list-style-type: none"> • All On/Off • On/Off • Mode • Setpoint • Fan Speed • Air Direction (n/a for ducted units) • Filter Sign Reset • Prohibit Thermostat Functions • Occupied/Unoccupied All • Occupied/Unoccupied Cool Setpoints • Occupied/Unoccupied Heat Setpoints • Run Time Consumption Reset • ECONAVI-Human detection (if available) 	<p>Global and Individual Monitor/Status Objects</p> <ul style="list-style-type: none"> • On/Off • Mode • Setpoint • Fan Speed • Air Direction (n/a for ducted units) • Space Temperature • Prohibit Thermostat Functions • Filter Sign Reset • Unit and System Error Codes • CZ-CFUNC1U Error Codes (BAC-128) • Occupied/Unoccupied Mode • Today, Yesterday and Total Run Time Consumption

Note: Not all features are available on all indoor models

LonWorks Integration



CZ-CLNC1U

The CZ-CLNC1U LonWorks Interface can control up to 16 indoor units. Monitors and controls all generations of PACi, ECOi and ECOi EX systems. Connects directly into the communication bus and is field-configured via dip switches.

The CZ-CLNC1U offers the following setting and monitoring objects. Some objects are not available on all indoor models.

Indoor Unit Operation/Setting Objects

- On/Off
- Mode
- Setpoint
- Fan Speed
- Air Direction (n/a for Ducted Units)

Indoor Unit Monitor/Status Objects

- On/Off
- Mode
- Setpoint
- Fan Speed
- Air Direction
- Space Temperature
- Unit and System Error Codes

RAC Connectivity to PACi, ECOi and ECOi EX

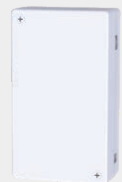

CZ-CAPRA1

This adapter serves as an interface required to connect a central control device, such as an intelligent controller, with the room air conditioner. Using this adapter can operate or monitor the room air conditioner from a central control device. Panasonic room air conditioners equipped with the CN-CNT terminal are supported.

Features: The following operations from the central control device can be performed

- Operations to start/stop the room AC, switch to operation mode, and set the temperature, fan speed and fan direction (up/down).
- Monitor the operation status and abnormality of room air conditioner.
- Prohibiting the remote control operation of room air conditioner
- Using On/Off contact of external connection can start/stop the room air conditioner, prohibit/permit the remote control operation, and perform emergency stop. A coin timer or card key can also be contacted.
- Retrieving the operation signal of abnormal signal of room air conditioner. (An external power source (DC12V) is separately required.)

Controllers, Communication and Integration

MODEL NO.	DESCRIPTION	USE WITH
RAC Wired Controllers		
CZ-RD516C-1	Wired Remote (for Wall Mount)	XE9WKUA, XE12WKUA, XE15WKUA, XE18WKUA, XE24WKUA XE9SKUA, XE12SKUA, XE15SKUA E9RKUA, E12RKUA, E18RKUA, E24RKUA E9NKUA, E12NKUA, E18NKUA, E24NKUA RE9SKUA, RE12SKUA, RE18SKUA, RE24SKUA
CZ-RD52CU	Wired Remote Controller (4-Way Ceiling Recessed)	4-Way Ceiling Recessed: E**RB4U
CZ-RD52DU	Wired Remote Controller (4-Way Ceiling Recessed)	Slit Duct: E**SD3UA
Interface Controls		
USPA-AC-WIFI-1B	Wi-Fi Interface for RAC (XE models, E9/E12NKUAW)	XE models, E9/12NKUAW, S9/12NKUA, ME7QKUA, ME7RKUA, E**RKUAW, E12/18RB4UW
USPA-RC2-WIFI-1	Wi-Fi Interface for Mini ECOi	All 26,000 – 42,000 BTU/h Models, except KS30/36NKU and KE 30/36NKU
USIS-IR-WIFI-1	Wi-Fi Interface for RAC	S18/24NKUA, E18/24NKUA, S9/12NKUW-1, S18/22NKU-1, KS12NB41, KS18NB4UW, MKS**NKU, MKS**NB4U, MKE**NKU, MKE**NB4U, KE18NB4UW, KS30/36NKU, KE30/36NKU
USPA-AC-BAC-1	BACnet Interface for RAC (XE / E**NKUA Series)	All XE, E9/12NKUA, S9/12NKUA, ME7QKUA, ME7RKUA, E**RKUAW, E12/18RB4UW
USPA-RC2-BAC-1	BACnet Interface for PAC & ECOi	All 26,000 – 42,000 BTU/h Models, except KS30/36NKU and KE30/36NKU

Accessories

ACCESSORIES		
WINDB-1A	Wind Baffle - Side Discharge Fan	YE9WKU1, YE12WKU1 22.5" wide - Single Fan - 1 Baffle, Double Fan - 2 Baffles
WINDB-M1	Wind Baffle - Small Multi/Large Single Coil Side	XE15WKUA, XE18WKUA, XE24WKUA, CU-2E18SBU, CU-3E19RBU, CU-E12RBU, CU-E18RBU, CU-E18RKUA, CU-E24RKUA, CU-RE18SKUA, CU-RE24SKUA, CU-E18SD3UA
WINDB-R1	Wind Baffle - Small Single Coil Side	XE9WKUA, XE12WKUA, CU-E12RBU, CU-E18RBU, CU-E9RKUA, CU-E12RKUA, CU-RE9SKUA, CU-RE12SKUA, CU-E9SD3UA, CU-E12SD3UA
WINDB-P1	Wind Baffle - Small PACi Single Coil Side	U-26PE1U6, U-36PE1U6
WINDB-P2	Wind Baffle - Large PACi and Mini ECOi Single Coil Side	U-36LE1U6, U-52LE1U6, U-42PE1U6
WINDB-XE1	Wind Baffle - XE only Coil Side	CU-XE9SKUA, CU-XE12SKUA, CU-XE15SKUA
WINDB-M2	Wind Baffle - Large Multi Coil Side	CU-4E24RBU-5, CU-5E36QBU-5
CZ-MA1P-US-BUND	Tube Size Reducer with Flare Nut (for multi-zone)	CU-2E18SBU-5, CU-3E19RBU-5, CU-4E24RBU-5, CU-5E36QBU-5
CZ-MA2P-US-BUND	Tube Size Reducer with Flare Nut (for multi-zone)	CU-3E19RBU-5, CU-4E24RBU-5
CZ-MA3P-US-BUND	Tube Size Reducer with Flare Nut (for multi-zone)	CU-3E19RBU-5, CU-4E24RBU-5
AUXHTK1	Auxiliary Heater Relay Kit	XE9WKUA, XE12WKUA, XE15WKUA, XE18WKUA, XE24WKUA
SI-30-120	Condensate Pump (Phase Out)	All 115v Models
SI-30-230	Condensate Pump	All 230v models. 5 gallons per hour
CZ-SA31P	PM 2.5 Filter	All XE
CZ-SA20P	Anti-Microbial Filter	All XE, E, RE wall mount
RCS4MHVB-J	Wireless Remote Caddy - Locking Bracket.	All PACi/ECOi Indoor
RCPTC110B-J	Wireless Remote Caddy - Locking Bracket.	XE**PKUA, XE**SKUA, E**NKUA and E**RKUA Models
RCPTC120SD-J	Wireless Remote Caddy - Locking Bracket.	E**SD3UAW
RCPTC130XE-J	Wireless Remote Caddy - Locking Bracket.	XE**SKUA

Line Sets

Single Split Line Set Connection Chart (for Multi Split connections refer to Tube Adapter chart)

LINE SET PART NUMBERS	Liquid Line		Suction Line		Insulation Thickness	Line Length	USE WITH
	inch		inch				
DLO4060815	1/4"	x	3/8"	x	1/2"	15'	XE9WKUA, XE9SKUA, E9RKUA, RE9SKUA, YE9WKU1, YE12WKU1, KE12SBU, E9SD3UA, CU-2E18SBU-5, CU-3E19RBU-5, CU-4E24RBU-5, CU-5E36QBU-5
DLO4060820	1/4"	x	3/8"	x	1/2"	20'	
DLO4060835	1/4"	x	3/8"	x	1/2"	35'	
DLO4080815*	1/4"	x	1/2"	x	1/2"	15'	XE12WKUA, XE15SKUA, XE15WKUA, XE18WKUA, XE12SKUA, E12RKUA, RE12SKUA, E12RB4U, E18RKUA, RE18SKUA, E18RB4U, E12SD3UA, E18SD3UA, CU-4E24RBU-5, CU-5E36QBU-5
DLO4080820*	1/4"	x	1/2"	x	1/2"	20'	
DLO4080835*	1/4"	x	1/2"	x	1/2"	35'	
DLO4100820	1/4"	x	5/8"	x	1/2"	20'	XE24WKUA, E24RKUA, RE24SKUA
DLO4100830	1/4"	x	5/8"	x	1/2"	30'	
DLO4100850	1/4"	x	5/8"	x	1/2"	50'	
DLO6100830	3/8"	x	5/8"	x	1/2"	30'	All 26,000 through 42,000 Btu/hr Models
DLO6100850	3/8"	x	5/8"	x	1/2"	50'	All 26,000 through 42,000 Btu/hr Models

* Use Noted Lines Sets with CS-E24RKUAW

Pipe Lengths, Fittings, Elevations and Refrigerant

SYSTEM MODEL	SYSTEM MODEL	OD Tube Size (inches)		Maximum Length of Tubing between In/Outdoor (ft)	Maximum Elevation Difference between In/Outdoor (ft)		Maximum BLength (ft) without Adding Refrigerant	Required Additional Refrigerant Oz/ft	Insulation
		Narrow	Wide		Outdoor Above	Outdoor Below			
Wall Mount	XE9WKUA	1/4	3/8	66	49	49	25	R410A 0.2	Both Tubes
	XE12WKUA	1/4	1/2	66	49	49	25	R410A 0.2	Both Tubes
	XE15WKUA	1/4	1/2	66	49	49	25	R410A 0.2	Both Tubes
	XE18WKUA	1/4	1/2	100	49	49	33	R410A 0.2	Both Tubes
	XE24WKUA	1/4	5/8	100	49	49	33	R410A 0.2	Both Tubes
	XE9SKUA	1/4	3/8	66	49	49	25	R410A 0.2	Both Tubes
	XE12SKUA-1	1/4	1/2	66	49	49	25	R410A 0.2	Both Tubes
	XE15SKUA-1	1/4	1/2	66	49	49	25	R410A 0.3	Both Tubes
	E9RKUA	1/4	3/8	66	49	49	25	R410A 0.2	Both Tubes
	E12RKUA	1/4	1/2	66	49	49	25	R410A 0.2	Both Tubes
	E18RKUA	1/4	1/2	100	49	49	33	R410A 0.3	Both Tubes
	E24RKUA	1/4	5/8	100	49	49	33	R410A 0.3	Both Tubes
	RE9SKUA	1/4	3/8	49	49	49	25	R410A 0.2	Both Tubes
	RE12SKUA	1/4	1/2	49	49	49	25	R410A 0.2	Both Tubes
	RE18SKUA	1/4	1/2	66	49	49	33	R410A 0.3	Both Tubes
	RE24SKUA	1/4	5/8	66	49	49	33	R410A 0.3	Both Tubes
	YE9WKU1	1/4	3/8	50	33	33	25	R410A 0.22	Both Tubes
	YE12WKU1	1/4	1/2	50	33	33	25	R410A 0.22	Both Tubes
	26PEK2U6	3/8	5/8	165	100	50	100	R410A 0.43	Both Tubes
	KE30NKUA	3/8	5/8	164	100	50	100	R410A 0.43	Both Tubes
KE36NKUA	3/8	5/8	164	100	50	100	R410A 0.43	Both Tubes	
KS30NKUA	3/8	5/8	164	100	50	100	R410A 0.43	Both Tubes	
KS36NKUA	3/8	5/8	164	100	50	100	R410A 0.43	Both Tubes	
4-Way Cassette	E12RB4U	1/4	1/2	66	49	49	25	R410A 0.2	Both Tubes
	E18RB4U	1/4	1/2	100	49	49	33	R410A 0.3	Both Tubes
	26PEU2U6	3/8	5/8	165	100	50	100	R410A 0.43	Both Tubes
	36PEU2U6	3/8	5/8	165	100	50	100	R410A 0.43	Both Tubes
	42PEU2U6	3/8	5/8	165	100	50	100	R410A 0.43	Both Tubes
Concealed Duct	E9SD3UA	1/4	3/8	66	49	49	25	R410A 0.2	Both Tubes
	E12SD3UA	1/4	1/2	66	49	49	25	R410A 0.2	Both Tubes
	E18SD3UA	1/4	1/2	100	49	49	25	R410A 0.3	Both Tubes
	26PEF2U6	3/8	5/8	165	100	50	100	R410A 0.43	Both Tubes
	36PEF2U6	3/8	5/8	165	100	50	100	R410A 0.43	Both Tubes
Ceiling Suspended	26PET2U6	3/8	5/8	165	100	50	100	R410A 0.43	Both Tubes
	36PET2U6	3/8	5/8	165	100	50	100	R410A 0.43	Both Tubes
	42PET2U6	3/8	5/8	165	100	50	100	R410A 0.43	Both Tubes
Multi-Split	CU-2E18SBU-5	1/4	3/8*	82	49	25	66	R410A 0.2	Both Tubes
	CU-3E19RBU-5	1/4	3/8	82	49	25	98	R410A 0.2	Both Tubes
	CU-4E24RBU-5	1/4	3/8	82	49	25	147	R410A 0.2	Both Tubes
	CU-5E36QBU-5	1/4	3/8*	80	49	25	150	R410A 0.2	Both Tubes

Important: You must use refrigerant piping rated for R410a.

*Reducing adapter may be required depending on indoor model to be used with. (CZ-MA1P, CZ-MA2P or CZ-MA3P)

Operation Range

XE9/12/15/18/24 Models			
Single Zone			
Cooling	Temperature	Indoor Air Intake Temp.	Outdoor Air Intake Temp.
	Maximum	89.6F DB / 73.4F WB	114.8F DB / 78.8F WB
Minimum	60.8F DB / 51.8F WB	0F DB / - F WB	
Heating	Maximum	86.0F DB / - WB	75°F DB / 64°F WB
	Minimum	60.8F DB / - WB	-15F DB / -16F WB

Exterios XE (CU-XE 9/12/15 SKUA)			
Single Zone			
Cooling	Temperature	Indoor Air Intake Temp.	Outdoor Air Intake Temp.
	Maximum	90°F DB / 74°F WB	115°F DB / 79°F WB
Minimum	61°F DB / 52° WB	0°F DB / -° WB	
Heating	Maximum	86°F DB / -° WB	75°F DB / 64°F WB
	Minimum	61°F DB / -° WB	-15°F DB / -16°F WB

Exterios E (CU-E 9/12/18/24 RKUA)			
Single Zone			
Cooling	Temperature	Indoor Air Intake Temp.	Outdoor Air Intake Temp.
	Maximum	90°F DB / 74°F WB	115°F DB / 79°F WB
Minimum	61°F DB / 52°F WB	0°F DB / -° WB	
Heating	Maximum	86°F DB / -° WB	75°F DB / 64°F WB
	Minimum	61°F DB / -° WB	-5°F DB / -6.8°F WB

Pro RE (CU-RE 9/12/18/24 SKUA)			
Single Zone			
Cooling	Temperature	Indoor Air Intake Temp.	Outdoor Air Intake Temp.
	Maximum	90°F DB / 74°F WB	115°F DB / 79°F WB
Minimum	61°F DB / 52°F WB	0°F DB / -° WB	
Heating	Maximum	86°F DB / -° WB	75°F DB / 64°F WB
	Minimum	61°F DB / -° WB	-4°F DB / -5.8°F WB

YE9/12 115V Models			
Single Zone			
Cooling	Temperature	Indoor Air Intake Temp.	Outdoor Air Intake Temp.
	Maximum	89.6F DB	122.0F DB
Minimum	62.6F DB	5.0F DB	
Heating	Maximum	86.0F DB	86.0F DB
	Minimum	32.0F DB	-13F DB

4-Way Ceiling Cassette (CU-E 12/18 RB4U)			
Single Zone			
Cooling	Temperature	Indoor Air Intake Temp.	Outdoor Air Intake Temp.
	Maximum	90°F DB / 74° WB	115°F DB / 79°F WB
Minimum	61°F DB / 52° WB	0°F DB / -° WB	
Heating	Maximum	86°F DB / -° WB	75°F DB / 64°F WB
	Minimum	61°F DB / -° WB	5°F DB / 3.2°F WB

Slim Duct (CU-E 9/12/18 SD3UA)			
Single Zone			
Cooling	Temperature	Indoor Air Intake Temp.	Outdoor Air Intake Temp.
	Maximum	90°F DB / 74° WB	115°F DB / 79° WB
Minimum	60°F DB / 52° WB	0°F DB / -° WB	
Heating	Maximum	86°F DB / -° WB	75°F DB / 64° WB
	Minimum	61°F DB / -° WB	-5°F DB / -6.8°F WB

Professional Series (U- 26/36/42 PE1U6) Wall Mount PK / Ceiling Suspended PT / 4-Way Cassette PU / Ducted PF			
Single Zone			
Cooling	Temperature	Indoor Air Intake Temp.	Outdoor Air Intake Temp.
	Maximum	90°F DB / 77°F WB	115°F DB / -° WB
Minimum	64°F DB / 57°F WB	0°F DB / -° WB	
Heating	Maximum	86°F DB / -° WB	75°F DB / 64°F WB
	Minimum	61°F DB / -° WB	-4°F DB / -4°F WB

Professional Series (KE 30/36 NKU)			
Single Zone			
Cooling	Temperature	Indoor Air Intake Temp.	Outdoor Air Intake Temp.
	Maximum	95°F DB / 71°F WB	115°F DB
Minimum	67°F DB / 57°F WB	0°F DB	
Heating	Maximum	80°F DB / 67°F WB	75°F DB / 65°F WB
	Minimum	-° DB / -° WB	-° DB / 0°F WB

UL Listed or CSA approved 4 conductor wires minimum AWG16. Wiring size may vary based on length and should verify with a licensed electrician. Supply power and inter connecting wiring must be ran in separate conduits.

Professional Series (KS 30/36 NKU) Cooling Only			
Single Zone			
Cooling	Temperature	Indoor Air Intake Temp.	Outdoor Air Intake Temp.
	Maximum	95°F DB / 71°F WB	115°F DB
Minimum	67°F DB / 57°F WB	0°F DB	

CU-2E18NBU			
Multi-Zone			
Cooling	Temperature	Indoor Air Intake Temp.	Outdoor Air Intake Temp.
	Maximum	89.6°F DB / 73.4°F WB	109.4°F DB / 78.8°F WB
Minimum	60.8°F DB / 51.8°F WB	60.8°F DB / 51.8°F WB	
Heating	Maximum	86°F DB / - WB	75.2°F DB / 64.4°F WB
	Minimum	60.8°F DB / - WB	5°F DB / 3.2°F WB

CU-2E18SBU-5			
Multi-Zone			
Cooling	Temperature	Indoor Air Intake Temp.	Outdoor Air Intake Temp.
	Maximum	90°F DB / 74°F WB	115°F DB / 79°F WB
Minimum	61°F DB / 52°F WB	14°F DB / -° WB	
Heating	Maximum	86°F DB / - WB	75.2°F DB / 64.4°F WB
	Minimum	61°F DB / - WB	-5°F DB / -6.8°F WB

CU-3E19RBU-5 / CU-4E24RBU-5 / CU-5E36QBU-5			
Multi-Zone			
Cooling	Temperature	Indoor Air Intake Temp.	Outdoor Air Intake Temp.
	Maximum	89.6°F DB / 73.4°F WB	114.8°F DB / 78.8°F WB
Minimum	60.8°F DB / 51.8°F WB	14°F DB / - WB	
Heating	Maximum	86°F DB / - WB	75.2°F DB / 64.4°F WB
	Minimum	60.8°F DB / - WB	-5°F DB / -6.8°F WB

Single & Multi-Zone Wiring

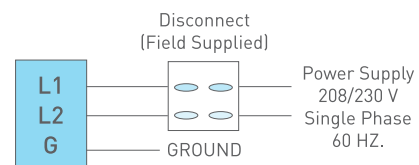
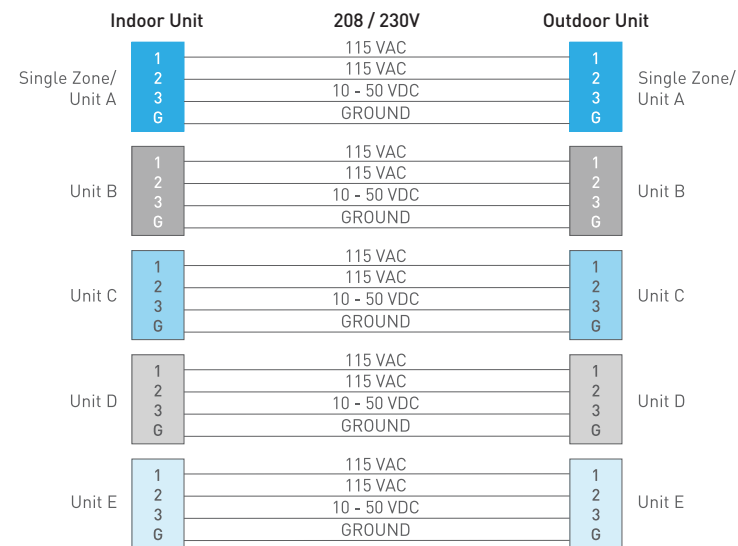

Multi-Zone Tube Adapters

Model Number CU-5E36QBU-5

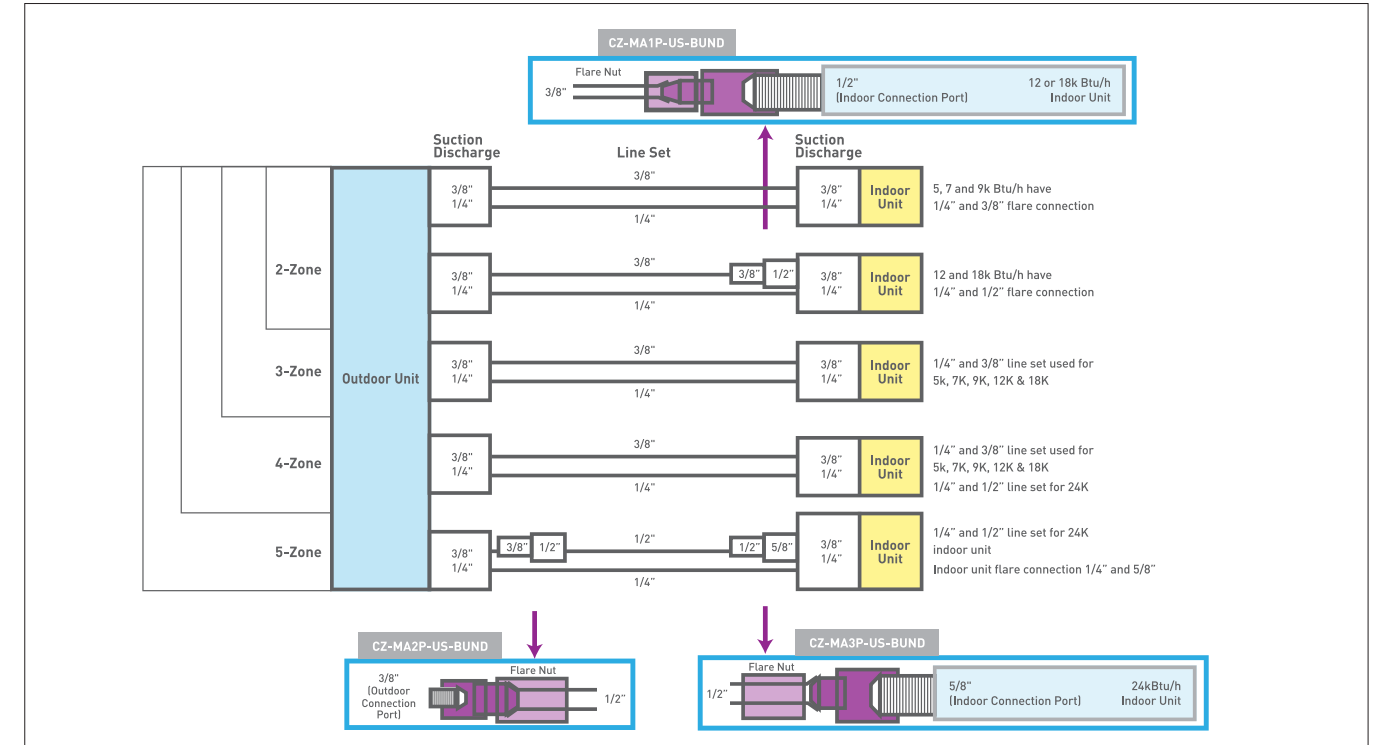

(Qty) and Adapter Required for Multi-Zone Installations

Adapter Chart		2 Zone CU-2E18NBU CU-2E18SBU-5		2-3 Zone CU-3E19RBU-5		2-4 Zone CU-4E24RBU-5		2-5 Zone CU-5E36QBU-5	
		O/D	I/D	O/D	I/D	O/D	I/D	O/D	I/D
Wall Mount	CS-ME5RKUA	none	none	none	none	none	none	none	none
	CS-ME7RKUA	none	none	none	none	none	none	none	none
	CS-E9RKUAW	none	none	none	none	none	none	none	none
	CS-E12RKUAW	none	(1) MA1P	none	(1) MA1P	none	(1) MA1P	none	(1) MA1P
	CS-E18RKUAW	N/A	N/A	none	(1) MA1P	none	(1) MA1P	none	(1) MA1P
	CS-E24RKUAW	N/A	N/A	N/A	N/A	(1) MA2P	(1) MA3P	(1) MA2P	(1) MA3P
	CS-XE9WKUAW	none	none	none	none	none	none	none	none
	CS-XE12WKUAW	none	(1) MA1P	none	(1) MA1P	none	(1) MA1P	none	(1) MA1P
	CS-XE15WKUAW	none	(1) MA1P	noe	(1) MA1P	none	(1) MA1P	none	(1) MA1P
	CS-XE18WKUAW	N/A	N/A	none	(1) MA1P	none	(1) MA1P	none	(1) MA1P
4-Way	CS-ME9SB4U	none	none	none	none	none	none	none	none
	CS-E12RB4UW	none	(1) MA1P	none	(1) MA1P	none	(1) MA1P	none	(1) MA1P
	CS-E18RB4UW	N/A	N/A	N/A	(1) MA1P	none	(1) MA1P	none	(1) MA1P
	CS-ME5SD3UA	none	none	none	none	none	none	none	none
Slim Duct	CS-ME7SD3UA	none	none	none	none	none	none	none	none
	CS-E9SD3UAW	none	none	none	none	none	none	none	none
	CS-E12SD3UAW	none	(1) MA1P	none	(1) MA1P	none	(1) MA1P	none	(1) MA1P
	CS-E18SD3UAW	N/A	N/A	N/A	(1) MA1P	none	(1) MA1P	none	(1) MA1P

none - no adapter required N/A - indoor does not match capacity of outdoor Ducted Multi-Zone Applications Available March 2017.

Adapter Model	(male/female)
CZ-MA1P-US-BUND	3/8" M x 1/2"F
CZ-MA2P-US-BUND	3/8" F x 1/2" M
CZ-MA3P-US-BUND	1/2" M x 5/8"F
Flare Nut (included)	



Note: Flare nut is usually supplied with all line sets. Panasonic also provides flare nut with adapter for contractor convenience.

Model Identification

RAC

Indoor Unit

C S - X E 1 2 S K U A

Outdoor Unit

C U - X E 1 2 S K U A

System

E 1 2 S K U A

1	Series	2	Model/Type	3	Connection configuration	4	Function	5,6	Capacity	7	Development	8	Category (Type)	9	Voltage	10	Others
C	Residential	S	Indoor unit U: Outdoor unit	X: Deluxe type K/None: Internal purpose MK: Indoor unit for Multi-Zone Connected Type (Multi-zone) Numerical: Numerical-K	S: Cooling only E: Heat pump	Cooling Capacity in BTU/h	Development Series No.	K: Wall Mount B4: Mini Ceiling Recessed K: Internal	U: 208/230V, 60Hz	-1: Non-Low Ambient W: Multi/Single Zone common use -1: Non-Low Ambient							

PAC

Indoor Unit

S - 26 P U 2 U6

Outdoor Unit

U - 36 P E 1 U6

Set

26 P E 2 U6

1	Model/Type	2	Capacity	3	Series	4	Category (Function)	5	Development	6	Voltage
S	Indoor unit	Cooling Capacity in BTU/h	P: Large Capacity series	K: Wall Mount U: Ceiling Recessed T: Ceiling suspended F: Concealed Duct S: Cooling Only E: Heat Pump	Development Series	U6: 208/230V 60Hz					
U	Outdoor Unit										

Sanyo to Panasonic Cross Reference

* H/P: Heat Pump, C/O: Cooling Only

PAC Outdoor 2 types / 10 models

Category	Capacity Kbtu/h	Sanyo Model No.	Panasonic Model No.	
PAC-i (Split)	H/P	26	CH2672R	U-26PETU6
		36	CH3672R	U-36PETU6
		42	CH4272R	U-42PETU6
		30	CH3082	CU-KE30NKKU
		36	CH3682	CU-KE36NKKU
	C/O	26	C2672R	U-26PSTU6
		36	C3672R	U-36PSTU6
		42	C4272R	U-42PSTU6
		30	C3082	CU-KS30NKUA
		36	C3682	CU-KS36NKUA

PAC Indoor 5 types / 15 models (13 models, Panel : 2 models)

Category	Capacity Kbtu/h	Sanyo Model No.	Panasonic Model No.	
4-Way Cassette	H/P	26	XHW2672R	S-26PUTU6
		36	XHW3672R	S-36PUTU6
		42	XHW4272R	S-42PUTU6
		Panel	PNR-XH2442	CZ-24KPU1U
		Panel	PNR-XH3642	CZ-36KPU1U
Wall Mount	H/P	26	KHS2672R	S-26PKTU6
		36	KS3082	CS-KS30NKKU
Wall Mount	C/O	42	KS3682	CS-KS36NKKU
		30	KHS3082	CS-KE30NKKU
		36	KHS3682	CS-KE36NKKU
Ceiling Suspended	H/P	26	THW2672R	S-26PTTU6
		36	THW3672R	S-36PTTU6
		42	THW4272R	S-42PTTU6
Duct	H/P	26	UHW2672R	S-26PFTU6
		36	UHW3672R	S-36PFTU6

RAC (37 models)

Category	Capacity Kbtu/h	Sanyo Model No.	Panasonic Model No.	
Mini Cassette	12	XS1271	CS-KS12NB4I	
	Panel	PNR-XS1872	CZ-18BT1U	
Outdoor Unit	Inv C/O	12	CL1271	CU-KS12NK1A
		18	C1872	CU-KS18NKKU
		18	CL1872	CU-KS18NK1A
		24	C2472	CU-KS24NKKU
		24	CL2472	CU-KS24NK1A
Wall Mount	Inv H/P	18	KHS1872	CS-KE18NKKU
		24	KHS2472	CS-KE24NKKU
Mini Cassette	Inv H/P	12	XHS1271	CS-KE12NB4I
		18	XHS1872	CS-KE18NB4UW
Outdoor Unit	Panel	12	CH1271	CZ-18BT1U
		18	CH1872	CU-KE18NKKU
		24	CH2472	CU-KE24NKKU
		7	KMS0772	CS-MKS7NKKU
		9	KMS0972	CS-MKS9NKKU
Wall Mount	Flexi Multi C/O	12	KMS1272	CS-MKS12NKKU
		18	KMS1872	CS-MKS18NKKU
		24	KMS2472	CS-MKS24NKKU
		9	XMS0972	CS-MKS9NB4U
		12	XMS1272	CS-MKS12NB4U
Outdoor Unit	Panel	12	CM1972A	CU-3KS19NBU
		24	CM2472A	CU-4KS24NBU
		31	CM3172A	CU-4KS31NBU
		7	KMS0772	CS-MKE7NKKU
		9	KMS0972	CS-MKE9NKKU
Wall Mount	Flexi Multi H/P	12	KMHS1272	CS-MKE12NKKU
		18	KMHS1872	CS-MKE18NKKU
		24	KMHS2472	CS-MKE24NKKU
		9	XMHS0972	CS-MKE9NB4U
		12	XMHS1272	CS-MKE12NB4U
Mini Cassette	Panel	12	CMH1972A	CU-3KE19NBU
		24	CMH2472A	CU-4KE24NBU
		31	CMH3172A	CU-4KE31NBU
		19	CMH1972A	CU-3KE19NBU
		24	CMH2472A	CU-4KE24NBU
Outdoor Unit	Panel	19	CMH1972A	CU-3KE19NBU
		24	CMH2472A	CU-4KE24NBU

Controllers

Category	Sanyo Model No.	Panasonic Model No.	
Wireless RC	Common	RCS-BH80AAB.WL	CZ-RWSC1U
	4-Way	RCS-SH80AAB.WL	CZ-RWSU1U
	Wall Mount	RCS-SH1AAB	CZ-RWSK1U
System Controller	SHA-KC64UG	CZ-64ESMC1U	
Simple Remote	RCS-KR1EG	CZ-REZC2	
Simple Wired RC	NEW	CZ-RELC2	
Wireless RC	U1/T1 Series	RCS-SH80UA.WL	CZ-RWSU2U
Wired Kit		STK-KCW1	CZ-RC515U
		STK-KCW2	CZ-RC515UA
Wired RC	STK-RCS-7TWSUA	CZ-RD515U	

Accessories

Category	Sanyo Model No.	Panasonic Model No.	
Fresh Air intake	4-Way	CMB-GSJ80U	CZ-24BCU1U
	4-Way	CMB-GSJ140U	CZ-42BCU1U
Outdoor Bracket		STK-KSB2050	CZ-12UD1U
		STK-KSB5050	CZ-30UD1U

Rating Conditions

	Cooling	Heating
Inside air temperature	80°F DB / 67°F WB	70°F DB / 60°F WB
Outside air temperature	95°F DB (75°F WB)	47°F DB / 43°F WB

NOTES

Panasonic®



Use of the AHRI Certified™ mark indicates a manufacturer's participation in the certification program. For verification of certification for individual products, go to www.ahridirectory.org



Quality Management System Certificate



SIRSI
Certified to ISO 9001: 2008
Cert. No.: MY-AR 1010

Certified to ISO 9001: 2008

Panasonic Appliance Air Conditioning Malaysia Sdn.Bhd.
Cert. No.: MY-AR 1010

Environmental Management System Certificate



SIRSI
Certified to ISO 14001: 2004
Cert. No.: MY-ER 0112

Certified to ISO 14001: 2004

Panasonic Appliance Air Conditioning Malaysia Sdn.Bhd.
Cert. No.: MY-ER 0112

**Standard warranty - 7 years compressor/5 years parts.
For extended product warranty, please contact your local authorized dealer for more information.**

CAUTION RELATED TO SAFETY
Do not add or replace refrigerant other than the specified type. Manufacturer is not responsible for the damage and deterioration in safety due to usage of other refrigerant.

Panasonic Corporation of North America

Panasonic Appliances Air-Conditioning of North America
Division of Panasonic Corporation of North America
2 Riverfront Plaza, Newark, NJ 07102

Customer Service: 800-851-1235

Panasonic Canada Inc.

Enterprise Product Sales
5770 Ambler Dr., Mississauga, ON, L4W 2T3 CANADA
na.panasonic.com/ca/hvac



Because its products are subject to continuous improvements, Panasonic reserves the right to modify product design and specifications without notice and without incurring any obligations.
©Copyright JUNE 2021, Panasonic Air Conditioning Products.